

EMR4

Setup and Operation Manual

Notice

Veeder-Root makes no warranty of any kind with regard to this publication, including, but not limited to, the implied warranties of merchantability and fitness for a particular purpose.

Veeder-Root shall not be liable for errors contained herein or for incidental or consequential damages in connection with the furnishing, performance, or use of this publication.

Veeder-Root reserves the right to change system options or features, or the information contained in this publication.

This publication contains proprietary information which is protected by copyright. All rights reserved. No part of this publication may be photocopied, reproduced, or translated to another language without the prior written consent of Veeder-Root.

Contact Technical Support for additional troubleshooting information at 800-323-1799.

DAMAGE CLAIMS / LOST EQUIPMENT

Thoroughly examine all components and units as soon as they are received. If any cartons are damaged or missing, write a complete and detailed description of the damage or shortage on the face of the freight bill. The carrier's agent must verify the inspection and sign the description. Refuse only the damaged product, not the entire shipment.

Veeder-Root must be notified of any damages and/or shortages within 30 days of receipt of the shipment, as stated in our Terms and Conditions.

VEEDER-ROOT'S PREFERRED CARRIER

1. Contact Veeder-Root Customer Service at 800-873-3313 with the specific part numbers and quantities that were missing or received damaged.
2. Fax signed Bill of Lading (BOL) to Veeder-Root Customer Service at 800-234-5350.
3. Veeder-Root will file the claim with the carrier and replace the damaged/missing product at no charge to the customer. Customer Service will work with production facility to have the replacement product shipped as soon as possible.

CUSTOMER'S PREFERRED CARRIER

1. It is the customer's responsibility to file a claim with their carrier.
2. Customer may submit a replacement purchase order. Customer is responsible for all charges and freight associated with replacement order. Customer Service will work with production facility to have the replacement product shipped as soon as possible.
3. If "lost" equipment is delivered at a later date and is not needed, Veeder-Root will allow a Return to Stock without a restocking fee.
4. Veeder-Root will NOT be responsible for any compensation when a customer chooses their own carrier.

RETURN SHIPPING

For the parts return procedure, please follow the appropriate instructions in the EMR Products General Returned Goods Policy pages in the EMR4 Products price list. Veeder-Root will not accept any return product without a Return Goods Authorization (RGA) number clearly printed on the outside of the package.

Introduction

System Features:	1
System Setup	1
Setup Mode	1
C&C Mode	2
Related Manuals	2
Safety Symbols	3
Safety Warnings	3
Display Head	4
Boot-Up Test Sequence	5
Activating the Display	6
OEM Message Disabled	6
OEM Message Enabled	6
Display Value Fields	6
Register Field	6
Preset Field	6
Totalizer Field	6
Descriptor Field	6
Display icons and indicators	6
Display Button Functions - Standard Keypad	7
Display Button Functions - Optional Keypad	7

Data Entry

Navigation Buttons	8
Data Entry with Standard Keypad	8
Data Entry with Optional Keypad	9

EMR4 Operating States and Modes

System Operating States	10
Pre-Dispense State	10
Dispense State	10
Finish State	10
System Operating Modes	10
Volume Mode	10
Currency Mode	10
Rate Mode	10
Setup Mode	11
Calibration and Configuration (C&C) Mode	11

Setup Mode

Initiating the Setup Mode	12
Setup Mode Categories	12
Enter Security Code	13
Pricing	14
Tax/Discount	15
Defaults	16
Relay Control	19
Security	20
Printer Option	21
View Records	23
Restore Records	24
Shift	25
Date Format	26
Time/Date	27

System Address	27
Time Delays.....	29
Version Number.....	30
C&C Mode	
Initiating the C&C Mode	31
C&C Mode Setup Categories	31
Language.....	32
Display Syntax.....	35
Temperature	36
Fuel Source	37
Temperature Compensation Method - Coefficient of Expansion.....	40
Temperature Compensation Method - Density Ratios for Liquified Petroleum Products.....	43
Meter Calibration	44
Configure I/O	47
OEM Message.....	47
Delivery Options	48
Report Formats.....	49
Restart.....	52
Security Code	53
Exiting C&C Mode	53
Operation of the System	
Multiple Products	54
Single Deliveries	54
Multiple Deliveries	54
Transfer Deliveries	54
Multiple Products in Multiple Deliveries	54
Driver Selection of Price/with Tax Codes During Operation	54
Entry of Price Codes & Tax/Discount Assignment in Setup Mode	55
Entry of Tax/Discount lines to T/D Subtotal	55
Emergency Stop	55
Preset Operation and Tank Topping	55
Viewing Tank Load During a Delivery	56
Modifying the Tank Load - For Tank on a Fuel Delivery Vehicle	56
Temperature Compensation Delivery Feature	56
Changing Modes and Presets During Operation	56
Typical Dispensing Examples	57
Dispensing Volume without preset	57
Dispensing Volume without Price but with Preset before Dispensing	58
Dispensing Volume without Price but with Preset after Dispensing	58
Dispensing Currency with Price Code before Delivery but without Preset	58
Dispensing Currency with Price Code & Currency Preset before Delivery	58
Dispensing Currency with Price Code Before & Currency Preset After Dispensing.....	59
Dispensing Currency with Price Code and Volume Preset Before Dispensing	59
Dispensing Currency With Price Code & Volume Preset After Dispensing.....	60
Dispensing With Tank Id Enabled	60
Dispensing With Custom Fields Enabled	60
Dispensing With Batch Preset By Product Enabled	61
Dispensing With Gross Preset Enabled	61
Dispensing With Gross View Enabled.....	61
Dispensing With Multiple Deliveries Disabled	62
Dispensing With Multicalibrate 0.25% Diff Disabled.....	62

Reducing Slip Printer Font Size.....62
 Calibration Page Print.....62
 Select Product62

EMR4 Troubleshooting Guide

Available Documentation63
 Testing an EMR4System63
 Display Head63
 Lcd Display63
 Pulse Generator Input Check63
 Printer Check.....63
 EMR4 Informational Messages63
 New Calibration Required.....64
 No Records.....64
 Recalculating64
 No Price Entry64
 Select Product64
 Delivery Error Codes64
 E04 - Encoder Pulse Error.....64
 E06 - Temp Probe Too Hot64
 E07 - Temp Probe Too Cold.....64
 E08 - Temperature Probe Failure.....64
 System Error Codes65
 E20 - Relay Failure or E50 - IB Comm Failure65
 IB Indicator Lights and IB Self Checks65
 E66 - Printer Busy66
 Exc Error #####.....67
 Error.....67
 Relay Setup Error Codes67
 E60 - Stop Advance Error.....67
 Calibration Error Codes67
 E64 - Fuel Type Undefined.....67
 E65 - Calibration Error.....67
 Other Problems68
 System Boots Up Okay, but Display Keys Don't Respond.....68

Appendix A: EMR4 Setup - Programming Tips

Appendix B: Epson Printer Characters

Appendix C: External Sources of System Noise

Figures

Figure 1. Display Head Features4
 Figure 2. Display Head with Optional Keypad4
 Figure 3. All Segments Activated5
 Figure 4. All Zeros Activated in the Display Fields5
 Figure 5. Using Front Panel Buttons to Navigate in Setup8
 Figure 6. Logging In Using Default Passcode13
 Figure 7. Logging In Using Assigned Passcode13
 Figure 8. Logging Out13
 Figure 9. Pricing Setup14
 Figure 10. Tax/Discount Setup15
 Figure 11. Defaults Setup16

Figure 12.	Start Modes Setup	16
Figure 13.	Presets Setup	17
Figure 14.	End of Day Delivery Report	18
Figure 15.	Relay Control Setup	19
Figure 16.	Passcode and Setup Access Setup	20
Figure 17.	Printer Option Setup	21
Figure 18.	Delivery Ticket Format	22
Figure 19.	View Records Setup	23
Figure 20.	Restore Records Procedure	24
Figure 21.	Shift and Shift Report Setup	25
Figure 22.	Shift Report Format	26
Figure 23.	Date Format Setup	26
Figure 24.	Date/Time Setup	27
Figure 25.	System Address Setup	27
Figure 26.	IB Address Setup	28
Figure 27.	Head Address Setup	28
Figure 28.	Printer Address Setup	29
Figure 29.	Time Delay Setup	29
Figure 30.	Version Number Viewer	30
Figure 31.	Language Setup	32
Figure 32.	Printer Labels Setup	33
Figure 33.	Tax and Discount Label Group Codes	34
Figure 34.	Display Syntax Setup	35
Figure 35.	Temperature Setup	36
Figure 36.	Temperature Calibration Setup	36
Figure 37.	Fuel Source Setup	37
Figure 38.	Meter ID Setup	37
Figure 39.	Input Type Setup	38
Figure 40.	Product Description Setup	39
Figure 41.	Meter Calibration Setup	44
Figure 42.	Meter Auto Calibration Setup	44
Figure 43.	Meter MultiCalibration Setup	45
Figure 44.	Meter Manual Calibration Setup	46
Figure 45.	Configure I/O Setup	47
Figure 46.	OEM Message Setup	47
Figure 47.	Delivery Options	48
Figure 48.	Delivery and Shift Report Formats	50
Figure 49.	Delivery and Shift Report Formatting Examples	51
Figure 50.	Restart Options	52
Figure 51.	Security Code	53
Figure 54.	IB Tri-Color LED Status Flash Patterns	66

Tables

Table 1 -	EMR4 Default Syntaxes	35
Table 2 -	Product Temperature/Coefficient of Expansion Defaults	40
Table 3 -	Temperature/Coefficient of Expansion Defaults for Propane1	40
Table 4 -	Minimum & Maximum Product Densities at 15°C1	41
Table 5 -	12 Temperature/Density Pairs1,2	43

Introduction

This manual describes setup and operating procedures for the EMR4 Electronic Meter Register System. This manual assumes that the Display Head, Interconnect Box, and printer are installed and connected.

System Features:

- Time/Date stamping of transaction records
- Volume Mode
- Currency Mode
- Rate Mode
- Temperature Compensation with optional Temperature Probe

References to Time and Date, Currency/Pricing, and Temperature Compensation are found throughout this manual in setup charts and in operating instructions. The EMR will not display any setup steps connected to an option (in Setup or C&C Modes) if that option is not installed. When using this manual, please ignore any references to an option if it is not installed.

System Setup

There are two distinct categories of EMR4 setup; Setup Mode which can be accessed at any time by the equipment operator, and C&C (Configuration and Calibration) Mode which is only to be entered in accordance with Weights and Measures (W&M) requirements.

SETUP MODE

The Setup Mode can be accessed by the equipment operator to:

- Establish price, tax, and discount codes
- Set the shutoff points for preset flow control relays 1 and 2
- View/print delivery records
- Select a designated printer type
- Set system component addresses
- Set time delays to blank out display
- Enter shift times, tanker reloads, and print out end-of-shift activity reports
- Enter security codes which can be assigned to delivery functions to prevent unauthorized changes
- Provide Passcode login procedure for access to assigned setup categories
- Restore up to the last 50 transaction records from IB NVRAM storage to a replacement Display Head
- Select month, day, year date formats
- Enter system Time and Date
- View component version numbers
- View Tank Load while making deliveries.

C&C MODE

In the C&C Mode, the user has the ability to configure variables such that by changing them, they could impact the results of a given transaction. The C&C mode is accessed by the user, to calibrate the meter, prior to using the EMR for customer transactions. With a C&C mode switch in place, a mechanical interlock or seal is typically added by a weights and measures inspector during calibration of the EMR. Once the seal is in place, access to the C&C parameters is not possible. To access the C&C Mode again, the weights and measures seal must be removed.

The same is true for the OBC commands that are related to C&C parameters in that commands are available when the EMR is not in the C&C mode but are available in the Delivery Mode.

The C&C Mode setups must be performed before you make selections in the non-metrological controlled Setup Mode - **There is one exception:** When initially powering up an EMR4 System with two Display Heads, System Address Setup (in Setup Mode) must be completed before entering C&C Mode (see page 27 to page 29).

Entering the C&C Mode requires that a seal-protected wire jumper or switch in the Display Head be changed. Changes in this mode must be accordance with local W&M authority requirements. In the C&C Mode you:

- Enter the meter input type and calibrate the meter
- Enter product descriptions
- Enter calibration and temperature compensation parameters
- Configure system I/O devices
- Enter the OEM message
- Select between coefficient of expansion or density as a method of temperature compensation for product delivery
- Enable price changing in the delivery state (if allowed)
- Enable system security code to limit unauthorized access to delivery setups
- Select and modify display formats, operating labels, and print labels
- Enable modifying of the Tank Load volume
- Perform a reboot with or without resetting setup parameters to their factory default positions





In the C&C Mode, the user has the ability to install software updates from an update flash drive.

Related Manuals





577014-352 EMR4 Operator Quick Help

Safety Symbols

The following safety symbols are used in this manual to alert you to important safety hazards and precautions.

 <p>EXPLOSIVE Fuels and their vapors are extremely explosive if ignited.</p>	 <p>FLAMMABLE Fuels and their vapors are extremely flammable.</p>
 <p>ELECTRICITY High voltage exists in, and is supplied to, the device. A potential shock hazard exists.</p>	 <p>READ ALL RELATED MANUALS Knowledge of all related procedures before you begin work is important. Read and understand all manuals thoroughly. If you do not understand a procedure, ask someone who does.</p>

Safety Warnings

 WARNING	
  	<p>This system operates near highly combustible fuel storage tanks. FAILURE TO COMPLY WITH THE FOLLOWING WARNINGS AND SAFETY PRECAUTIONS COULD CAUSE DAMAGE TO PROPERTY, ENVIRONMENT, RESULTING IN SERIOUS INJURY OR DEATH.</p> <p>To ensure proper installation, operation, and continued safe use of this product:</p> <ol style="list-style-type: none"> 1. Read and follow all instructions in this manual, including all safety warnings. 2. Have equipment installed by a contractor trained in its proper installation and in compliance with all applicable codes including: the National Electrical Code; federal, state, and local codes; and other applicable safety codes. 3. Ensure that this equipment is properly programmed. 4. Operate this equipment in accordance with the instructions in this manual. 5. Promptly investigate any alarm conditions. 6. Do not modify or use service parts other than those provided by Veeder-Root. Substitution of components may impair intrinsic safety.

Display Head

The EMR4 Display Head display features are shown in Figure 1 and Figure 2.

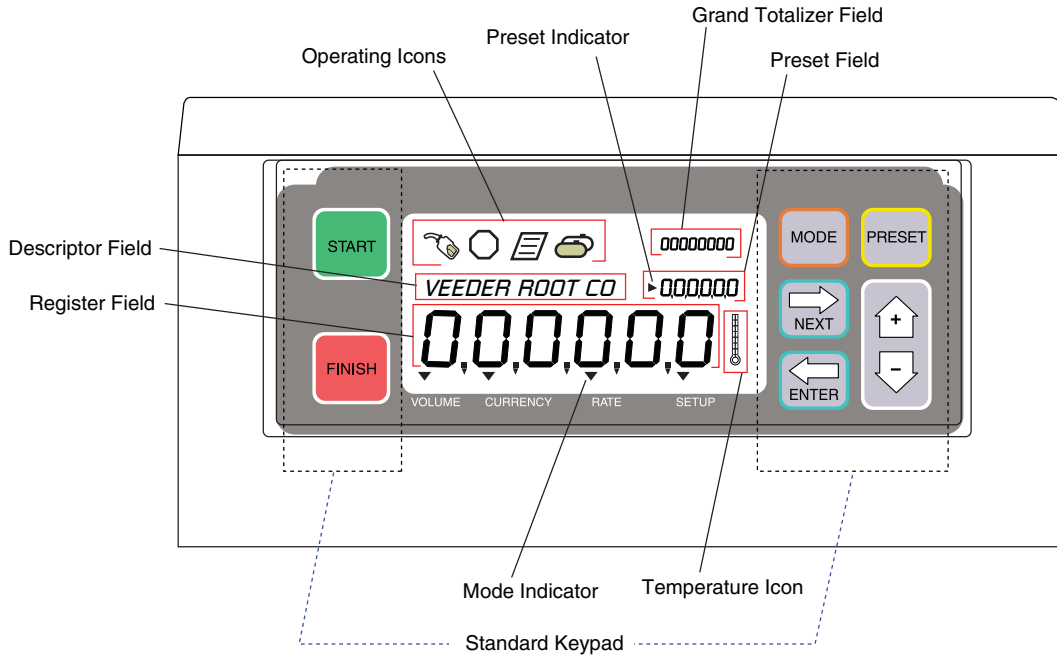

Figure 1. Display Head Features

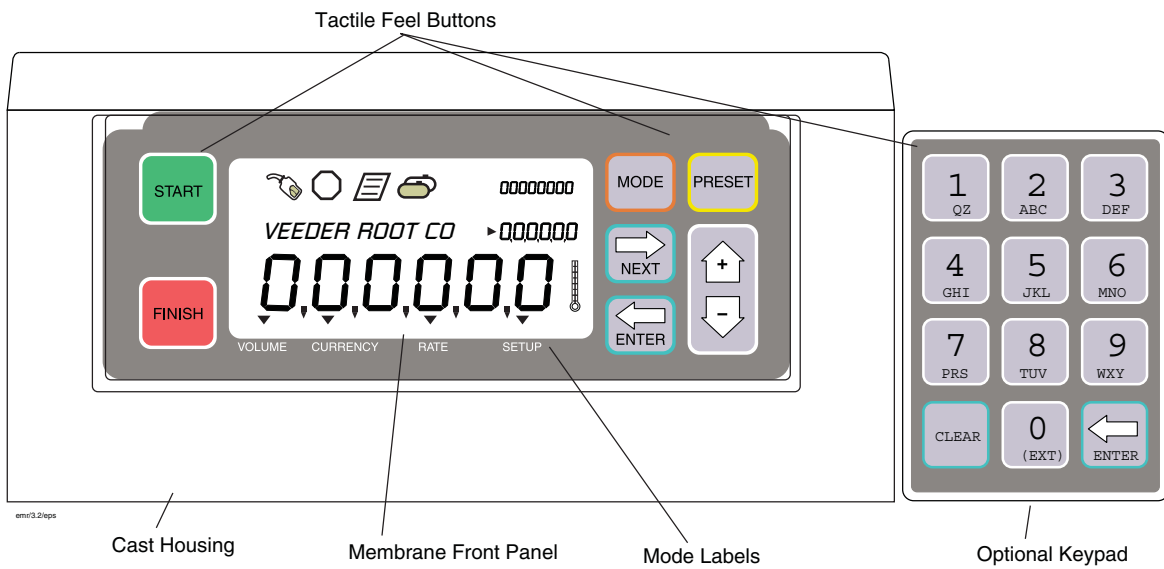

Figure 2. Display Head with Optional Keypad

Boot-Up Test Sequence

When power is initiated to the Display Head, the screen will power up with a test sequence that satisfies the requirements of the local Weights and Measures authority. The Display Head test sequence follows below:

- Run self tests
- Self test passed
- Checksum
- All segments of the display are activated (see Figure 3)

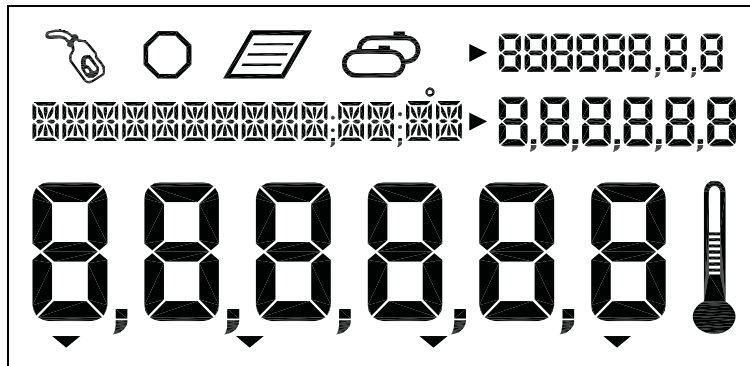

Figure 3. All Segments Activated

- All zeros appear in the four display value fields (see Figure 4)

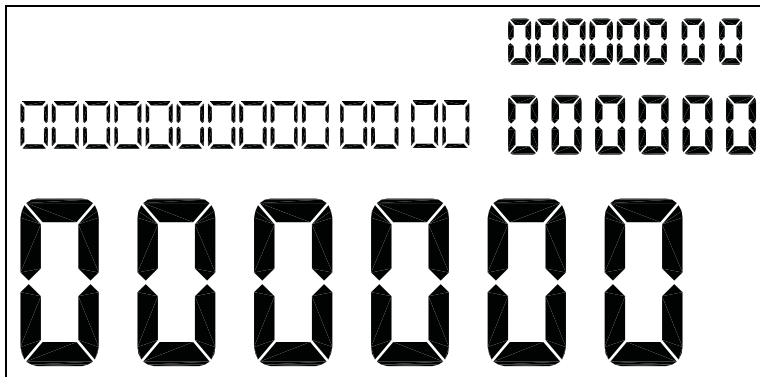

Figure 4. All Zeros Activated in the Display Fields

- Version number

On initial startup of EMR4 Systems with two Display Heads, you must go to the Head Address Setup (Figure 27 on page 28) and assign an unique Head Address for each Display Head. Because the factory default Head Address is set to a "1", one of the two Display Head's addresses must be changed to a "2". Caution! Failure to do so will cause communication problems which will result in erratic operation.

Subsequently, if no button press or operation occurs in 30 seconds, the display will go blank and wait for a button to be pressed to reactivate. Initially, when reactivated, the Display Head enters the Volume mode.

Once the unit has been setup, the default reactivation mode will be the Pre-Dispense mode you choose in setup. Also, if you enable the OEM message in setup, it will scroll across the Descriptor field until the 30 second timeout.

Activating the Display

OEM MESSAGE DISABLED

Display is blank after the 30 second timeout. Press a button on the display, if the timeout follows setup, the pre-dispense default mode is displayed. Otherwise the display on the screen prior to the timeout will display.

OEM MESSAGE ENABLED

Display is blank after 30 second timeout. Press a button on the display, the OEM message scrolls in the Descriptor field. Press a button on the display, if the timeout follows setup, the pre-dispense default mode is displayed. Otherwise the display on the screen prior to the timeout will display.

Display Value Fields

REGISTER FIELD

Six digits display the current volume, currency value, final price, or rate of fuel dispensed. The area is used to display different selections. Values may display in various resolutions by selecting options in the C&C Mode. Decimal and comma selection is available in this mode for 5 of the 6 digits.

PRESET FIELD

Six digits display the volume preset, volume preset count down, price, currency preset values, currency preset count down or tank load. The area is used to enter different selections of price, volume preset, currency preset, or modify tank load. Values may display in various resolutions by selecting options in the C&C Mode. Decimal and comma selection is available in this mode for 5 of the 6 digits.

TOTALIZER FIELD

Eight digits display the grand totalizer volume dispensed for the life of the product. Decimal selection is available in this mode for 2 of the 8 digits.

DESCRIPTOR FIELD

Fourteen Characters at one time, with a rolling text capability for extended messages (up to 24 characters total), displays description of values, labels, time/date, and instructional messages. Labels, descriptions, and messages are changeable in C&C Mode. Error codes will appear also in this field.

Display icons and indicators

- **Emergency Stop** - Octagon icon displayed when optional emergency stop switch contacts are closed (they can be active open or closed, configurable in C&C mode). This remote switch will be mounted near the Display Head and is pushed to stop flow and pulled to resume flow.
- **Fueling** - Fuel nozzle icon displayed constantly when system is ready to dispense. The Icon will flash when approaching the time-out in delivery mode (30 seconds). See single delivery mode for further explanation.
- **Temperature** - The thermometer icon will display only when a temperature compensated product is selected.
- **Printer** - A page icon will display only when a printer is configured for the system. A slow flashing page icon is displayed when the printer is actively printing. A fast flashing page icon is displayed when the printer requires operator attention.
- **Multiple Delivery** - The multi-tank icon will display when the multiple delivery state is initiated.
- **Mode Indicators** - An indicator icon will point to the current Mode (Volume, Currency, Rate, or Setup) when appropriate.

- **Preset Indicator** - An indicator icon will point to the Preset Field to indicate the Status of the Preset when in that mode, otherwise it will not appear. It will flash when the Preset is set but disabled and will remain solid when the Preset is enabled.

Display Button Functions - Standard Keypad



- **START** - Press to begin a fuel dispense transaction. When START is depressed for more than (2) seconds multiple delivery mode is initiated. When in multiple delivery mode, press START to stop the current dispense and start the next one.
- **FINISH** - Press to end a fuel dispense transaction. After transaction is complete, pressing FINISH will clear the display of the last transaction and return you to the Pre-Dispense state. Press FINISH to toggle between displaying the last transaction and the Pre-Dispense state. If depressed for more than a second after transaction completed and last dispense is called, pressing FINISH initiates a Duplicate Ticket.

When multiple products are available and you are in the Select Product step prior to dispensing, pressing FINISH will exit the dispense state, and return you to the pre-dispense state.

- **MODE** - Prior to pressing START Button, press MODE to cycle between Volume, Currency, and Setup Modes. After pressing START Button, press MODE to cycle between Volume, Currency, and Rate Modes.
- **PRESET** - In Volume Mode, press to initiate presetting the amount of volume to dispense. Used in conjunction with the NEXT, '+', '-', and ENTER Buttons to set a preset value.

In Currency Mode, press to toggle between price screen and currency preset screen. Used in conjunction with the NEXT, '+', '-', and ENTER Buttons to select and set a Price or a preset value.

When the View Tank Load feature is enabled, press to view the tank load volume before or during a delivery. When both View Tank Load and Tank Load features are enabled, press to modify the tank load volume after refilling the tank.

- **NEXT** - Press to enter the value fields - task or function. It is used also to move to the next lesser digit or next letter in an entry to a value field. At the least significant digit it will wrap to the most significant digit.
- **ENTER** - Press to accept selection of parameter or alphanumeric values, or to return to prior menu selection.
-  Plus button which you press to scroll upward through the menu selections, to increment through numeric characters 0 to 9, alpha characters Z to A, and special characters for each position in a selected display. Note: throughout this manual, '+' button will also refer to this button.
-  Minus button which you press to scroll downward through the menu selections, to move from alpha characters A to Z, numeric characters 9 to 0, and special characters for each position in a selected display. Note: throughout this manual, '-' button will also refer to this button.

Display Button Functions - Optional Keypad

- **0 through 9** - Press to enter alpha, numeric, or special character value into an active field. In alpha or numeric selections, the cursor advances automatically upon selection of the next number or a different character represented by the same button (negates the requirement for the NEXT button to be depressed for that purpose).
- **CLEAR**
In the Preset Field, press to move the cursor forward one character.
In the Descriptor Field, press to erase the current character and move the cursor back one space. Depressing this button for 2 seconds erases the entire Descriptor Field.
- **ENTER** - Press to accept selection of parameter or alphanumeric values, or to return to prior menu selection (functions the same as the ENTER button on the standard keypad).

Data Entry

Navigation Buttons

The navigation buttons consist of the MODE, NEXT, ENTER, PRESET, and +/- buttons. They can be used to either select and set parameters, or select and set alpha and numeric values.

- **MODE** - Press to navigate through the Modes; Setup, Volume, Currency, and Rate.
- **NEXT** - Press to move to the next submenu for a selection of a parameter or an alpha (Descriptor Field) or (Preset Field) numeric selection.
- \triangle Press to scroll upward through the menu selections, to cycle through numeric characters 0 to 9, alpha characters Z to A, and special characters for each position in a selected display.
- ∇ Press to scroll downward through the menu selections, to cycle through alpha characters A to Z, numeric characters 9 to 0, and special characters for each position in a selected display.
- **ENTER** - Press to accept selection of parameter or alphanumeric values, or to return to prior menu selection.
- **PRESET** - Press to move to the preset countdown or preset entry.

Figure 5 illustrates the use of front panel buttons to make selections and navigate in Setup Mode.

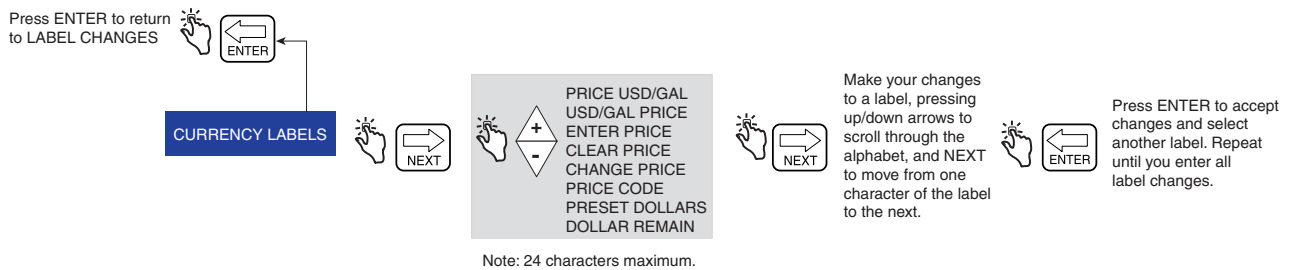

Figure 5. Using Front Panel Buttons to Navigate in Setup

Data Entry with Standard Keypad

Upon entering the Descriptor or Preset Field with the use of the navigation buttons, a blinking cursor appears in the far left of the field if, the field is empty or has a zero value. If the field contains data, a blinking cursor appears one position to the left of the first non-blank field.

Pressing the +/- buttons will scroll through alpha or numeric options for entry in the position. Holding down the +/- buttons will scroll automatically without having to depress the button for each value. Pressing the NEXT button will move the cursor to the right for the next position. During alpha entries numeric, special characters, and blanks are available. Pressing the NEXT button without scrolling to another selection will leave the current value and move to the next location.

Subsequent presses of the NEXT button will shift the selected entry point to the right so the next digit/alpha/space can be selected. When the last or least significant position is reached the subsequent press of the NEXT button will wrap around to the most significant position. When changes are complete, press ENTER to accept values.

Data Entry with Optional Keypad

Upon entering the Descriptor or Preset Field with the use of the navigation buttons the optional keypad will permit alpha and numeric entries.

To enter a numeric character in the Preset Field just select the appropriate button on the optional keypad. When a selection is made, the cursor will automatically sequence to the position to the right.

To enter an alpha, numeric, or special character in the Descriptor field, select the number button on the optional keypad containing that alpha or numeric. Sequential depressions of the button will step through the alpha and numeric values for that button. To move the cursor to the next position, the NEXT button can be depressed. Alternatively, when another, non-like button is depressed the cursor will move to the right and the selection of the value is obtained as aforementioned. In the case where the same alpha or numeric is desired the NEXT button will sequence the cursor to the next entry position.

When the desired entry is complete, press ENTER to accept.

The display head allows entries using both keypads in conjunction with each other or independently.

EMR4 Operating States and Modes

System Operating States

The system has three operating states, Pre-Dispense, Dispense, and Finish.

PRE-DISPENSE STATE

Prior to pressing the START button, the system is in the Pre-Dispense state. The setting of system parameters, pricing, and tax codes for a delivery are made in this state.

DISPENSE STATE

After pressing the START button (and selecting a product if set up for multiple products), the system enters the Dispense state.

FINISH STATE

After pressing the FINISH button, the system is in the Finish State. The ticket is printed and the last delivery is displayed. Pressing the FINISH button again will change the system to Pre-Dispense state.

System Operating Modes

Four operating modes are used in the EMR4 System. They are Volume, Currency, Rate, and Setup. These modes can be navigated by use of the MODE button. In Setup, the default Mode for Pre-Dispense and Dispense states can be set. The defaults may be changed through the User Setup menus

VOLUME MODE

The display will default to the Volume mode when the display head is first initialized. In the Pre-Dispense or Dispense state the display will initiate with volume displayed in the numeric fields. Prior to the START button being pressed, the mode will remain in Volume unless the MODE button is depressed to change the mode. It may be changed to Currency, Setup, and back to Volume. If the mode is changed to Currency or Setup prior to delivery, the mode will change to the default dispense state selected when the START button is depressed to begin that delivery. At any time, the operator may select the Currency Mode or Rate Mode by depressing the MODE Button. When in the Volume Mode the indicator will point to the volume label on the front panel.

CURRENCY MODE

The display may be configured in the Setup Mode to default to the currency display. In the Pre-Dispense or Dispense state the display will initiate with currency displayed in the numeric fields. Prior to the START button being pressed, the mode will remain in Currency unless the MODE button is depressed to change the mode. It may be changed to Volume, Setup, and back to Currency. If the mode is changed to Volume or Setup prior to delivery, the mode will change back to the default Dispense state selected when the START button is depressed to begin that delivery. At any time, the operator may select the Volume Mode or Rate Mode by depressing the MODE Button. When in the Currency Mode the indicator will point to the currency label on the front panel.

RATE MODE

The display may show flow rate by depressing the MODE button when the operator is able to deliver product. The operator cannot access Rate Mode unless the START button initiating a delivery is pressed. The Rate Mode can be selected as the default dispense state in the Setup Mode. During a delivery, the operator may display the flow rate by using the MODE button to select Rate. When in the Rate Mode the indicator will point to the rate label on the front panel. If the Temp Probe is connected to the EMR4 and the Temperature Compensation is enabled, pressing the +/- buttons will show the current temperature. Pressing the navigation keys again will show back the RATE units.

SETUP MODE

The user can access the Setup Mode before a delivery to change a variety of parameters that are not required to be under weights & measure seal. Once the delivery state is active, the Setup Mode cannot be accessed. The Setup Mode is used to enter price codes, default mode setting, single flow and fast flow knock-off values and other non-metrological settings. The operator can exit the mode by depressing the MODE button at any time. When in the Setup Mode the indicator will point to the setup label on the front panel. Detailed information on how to set the parameters is explained the setup sections of this manual.

CALIBRATION AND CONFIGURATION (C&C) MODE

The C&C Mode is entered by a trained technician following instructions in the EMR4 Application Guide (V-R P/N 577014-339). When the display head is powered up after the C&C Mode is enabled, the C&C related parameters of the Setup Mode are displayed. C&C Mode is used to set up various calibration and configuration parameters, which when made, are sealed for metrological conformity. All C&C Mode parameters can be viewed by the user in the Setup Mode, but no changes are allowed. The operator can not exit the C&C Mode until the C&C switch is returned to its normal operating state.

Setup Mode

Initiating the Setup Mode

1. Turn On power to the Display Head and wait until the boot-up sequence completes.
2. Depress the MODE button until the indicator at the bottom of the display points to Setup.
3. On initial power-up of the Display Head, the first Setup Mode category, PRICING, displays in the Descriptor Field. Press NEXT to enter Pricing Setup, or continue to press the ∇ button to step through the remaining Setup Mode categories. Press NEXT to enter any category once it displays in the Descriptor Field.

Setup Mode Categories

The non-metrologically controlled Setup Mode categories for the EMR4 System are:

- **Enter Security Code** - enables user log in/out procedure (page 13). (Note: This prompt will not display on initial power-up of the Display Head. If you have enabled Security Code in the C&C Mode, this prompt will be the first category to display on entering Setup Mode).
- **Pricing** setup - sets up to 15 different price codes with tax/discount code assignments (see page 14).
- **Tax/Discount** setup - sets up to 15 different tax/discount (T/D/S) codes with up to 6 different T/D modifiers per code (see page 15).
- **Defaults** lets you set the mode you want the Display Head to enter when beginning pre-dispense and dispense operations; and lets you enable/disable volume and currency mode presets. In volume mode you enable/disable batch preset by product (see page 15).
- **Relay Control** setup - sets the shutoff points for flow control relays 1 and 2 for preset deliveries (see page 19).
- **Security** setup - sets the user Passcodes and user access to certain Setup Mode categories (see page 20). (This setup only displays after enabling Security Code in the C&C Mode).
- **Printer Option** setup - sets optional printer type and distance from top of ticket to first printed line, also can set Printer Font size (Slip Printer) and print Calibration Page (see page 21).
- **View Records** setup - lets you select to either view or print any of the last 50 transaction records (see page 23).
- **Restore Records** - Allows the user to restore (download from IB to Display Head) up to the last 50 transactions (see page 24).
- **Shift** setup - sets up shift time, tank load, and printer report. Also within Shift setup, you can print out shift reports (see page 25).
- **Date Format** setup - sets the format of year, month, and date for use in display and printouts (see page 26).
- **Time/Date** setup - lets you enter the current time and date (see page 27).
- **System Address** setup - sets the addressing and configuration of the individual EMR4 components and their inputs from, and outputs to, the system (see page 27).
- **Time Delays** setup - sets the delay (in seconds) after which the display will go blank if there is no activity (see page 29).
- **Version Number** - lets you view system device version numbers (see page 30).
- **C&C** - lets you step through and view, but not change, the C&C Mode setups (see page 31).

Instructions for setting up the Setup Mode categories are shown in the figures that follow. In some cases multiple figures are used to explain sub-procedures within a Setup Mode category.

Note, once you have entered a Setup Mode category (pressing NEXT), do not press the '+' or '-' buttons in that setup if you do not intend to change a value, because when you press ENTER, the change, even if unintended, will be accepted. If you want to view setup settings without making changes, press NEXT to move 'into' a category's setup and ENTER to 'back out' of the setup.

ENTER SECURITY CODE

NOTE: These menus do not appear until the SECURITY CODE feature is enabled in the C&C mode, described in Figure 51 of this manual.

Figure 6 illustrates the initial logging in procedure using the default Passcode after Security Codes are enabled in C&C Mode (see Figure 51). Figure 7 shows the procedure for logging in using an assigned Passcode, and Figure 8 shows how to log out.

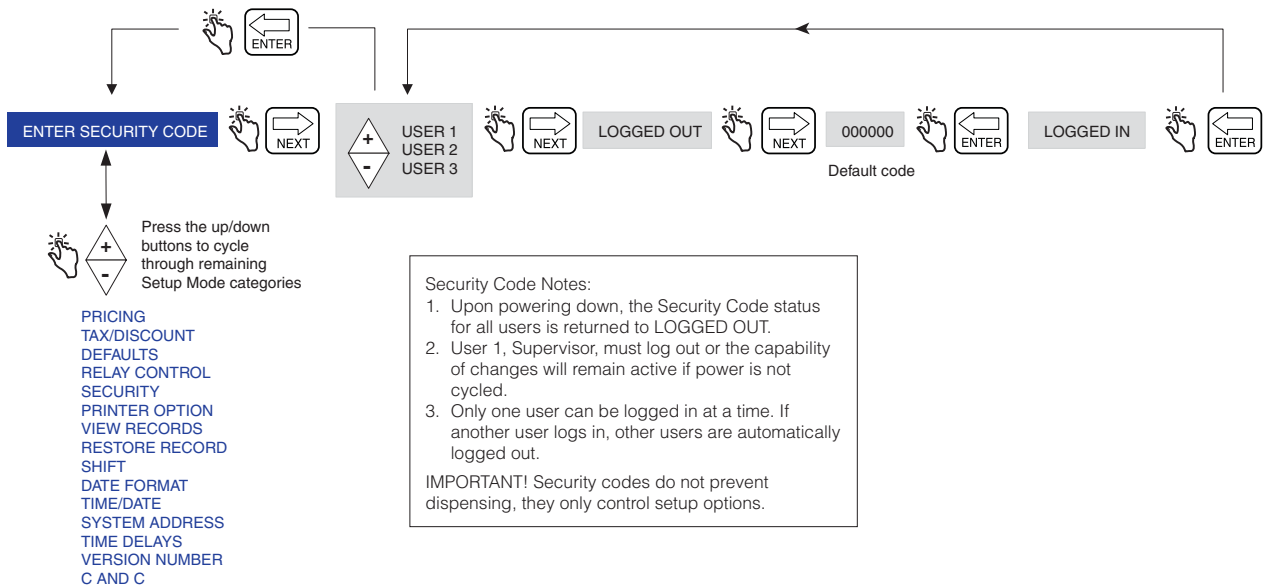

Figure 6. Logging In Using Default Passcode



Figure 7. Logging In Using Assigned Passcode

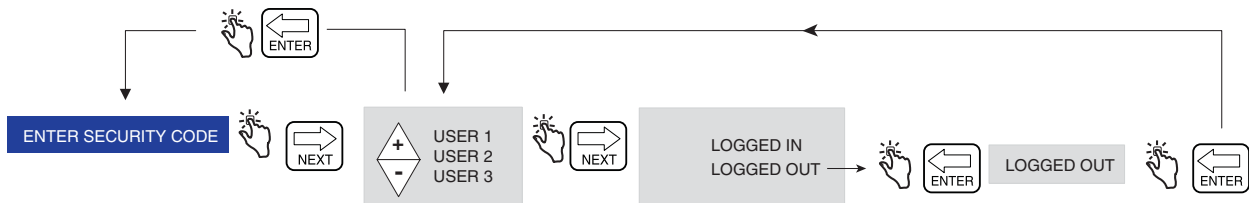

Figure 8. Logging Out

PRICING

Figure 9 illustrates Pricing setup in Setup Mode. Note: if user isn't logged in, the price cannot be changed.

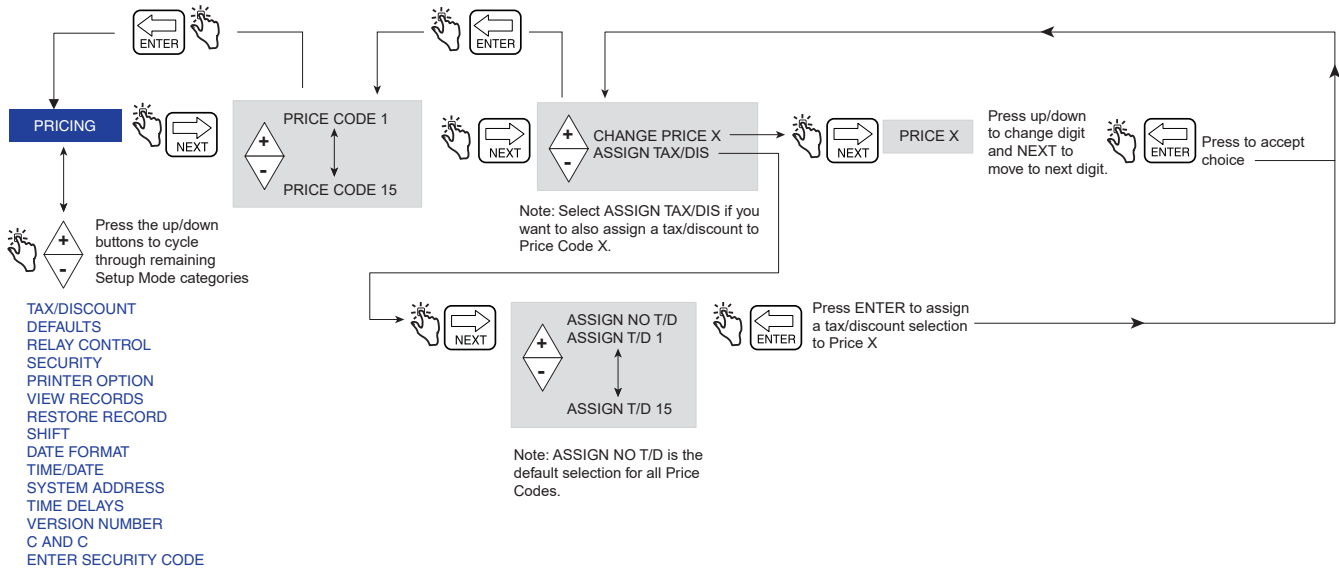

Figure 9. Pricing Setup

Figure 11 illustrates Defaults setup in Setup Mode.

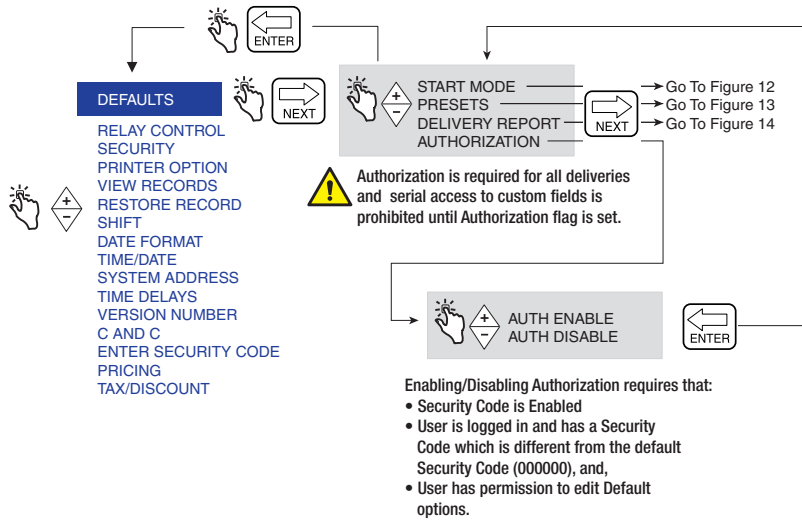

Figure 11. Defaults Setup

Start Modes

Figure 12 illustrates Start Modes selections under Defaults Setup. Start Modes is used to select the screen (mode) that will be displayed before the delivery (PRE-DISPENSE state) and during the delivery (DISPENSE state). The default Start Mode is Volume.

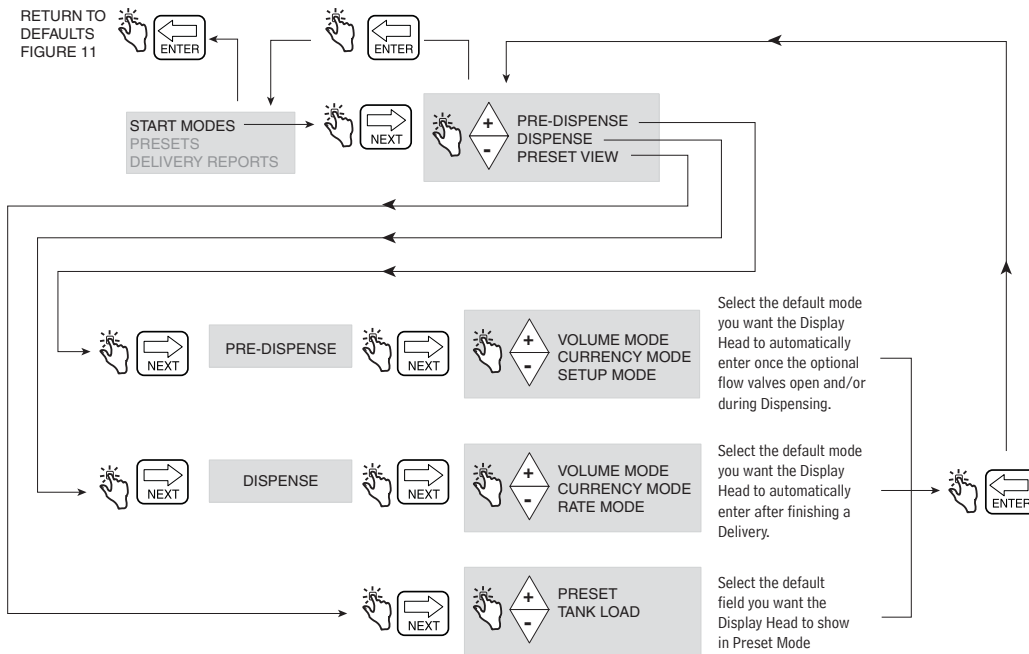

Figure 12. Start Modes Setup

Presets

Figure 13 illustrates delivery Presets setup in Setup Mode.

The PRESET ENABLE menu is associated with the PRESET INTERLOCK description and the BATCH ENABLE menu is associated with the TRANSFER INTERLOCK description. Interlock switches are not provided by Veeder-Root and are not required when using presets. For more information go to the CONFIGURE I/O menu description in Figure 45 of this manual. If desired, The Driver can be allowed to change the Preset/Batch presets in the Passcode and Setup Access setup in Figure 16.

A **Preset** delivery is either in units of volume or in units of currency. Once Preset is enabled, 3 preset currency or volume delivery amounts can be entered here.

A **Batch** delivery is in units of volume only. Once Batch is enabled, preset delivery volumes for up to 8 different products can be entered here. The Batch Function has the additional capability of printing a line of text when used with a “transfer” interlock switch.

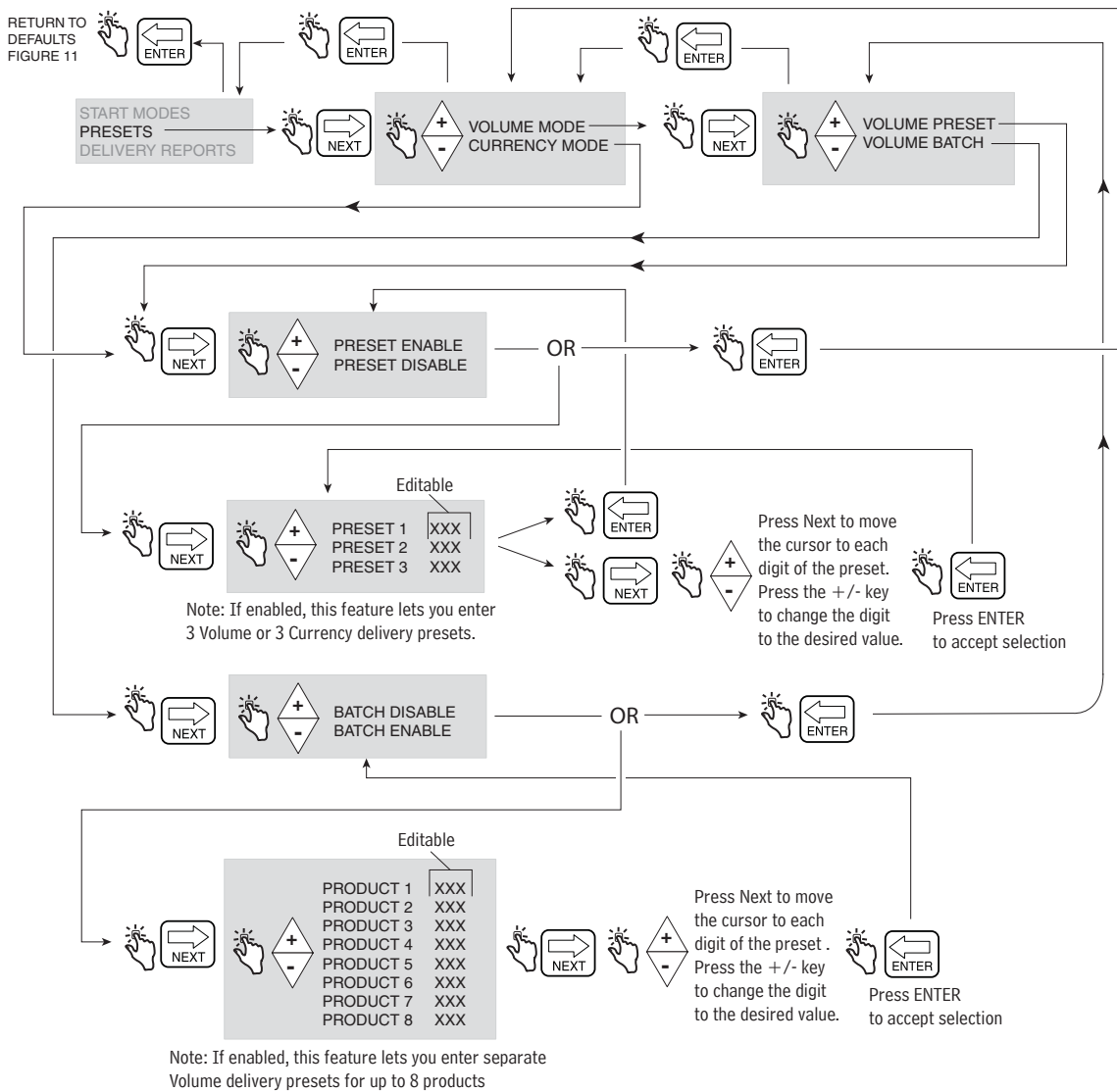
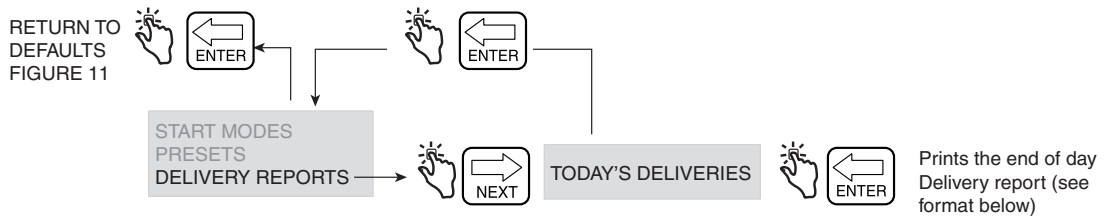

Figure 13. Presets Setup

Delivery Report

Figure 14 illustrates printing out the End of Day Delivery Report.



SUMMARY PRINTOUT	
Deliveries Made -	Feb-03-2011
02/03/2010-08:18:53 DIESEL	TKT #:10012 0 0.0 GALLONS
02/03/2010-08:23:15 DIESEL	TKT #:10012 0 24.5 GALLONS
02/03/2010-09:29:04 GASOLINE	TKT #:10012 0 0.0 GALLONS
02/03/2010-09:42:30 GASOLINE	TKT #:10012 0 3.7 GALLONS
02/03/2010-07:57:25 DIESEL	TKT #:10012 0 10.0 GALLONS
02/03/2010-08:00:34 GASOLINE	STKT #:10012 0 27.6 GALLONS
<i>Daily Totals</i>	
GASOLINE	31.3 GALLONS
DIESEL	34.5 GALLONS

This is an example of starting and stopping a delivery without running the pump.

Figure 14. End of Day Delivery Report

RELAY CONTROL

The EMR4 must be in Preset Mode to control the flow valve solenoid(s). For a single-stage flow valve, use Relay 2 (Stop), for a dual-stage flow valve, use Relay 1 (Slow) and Relay 2 (Stop).

NOTE: Pushing the FINISH button at any time will cause a manual override condition and both relays will open. When the relays open, both solenoids close, halting fuel flow.

Figure 15 illustrates Relay Control setup in Setup Mode.

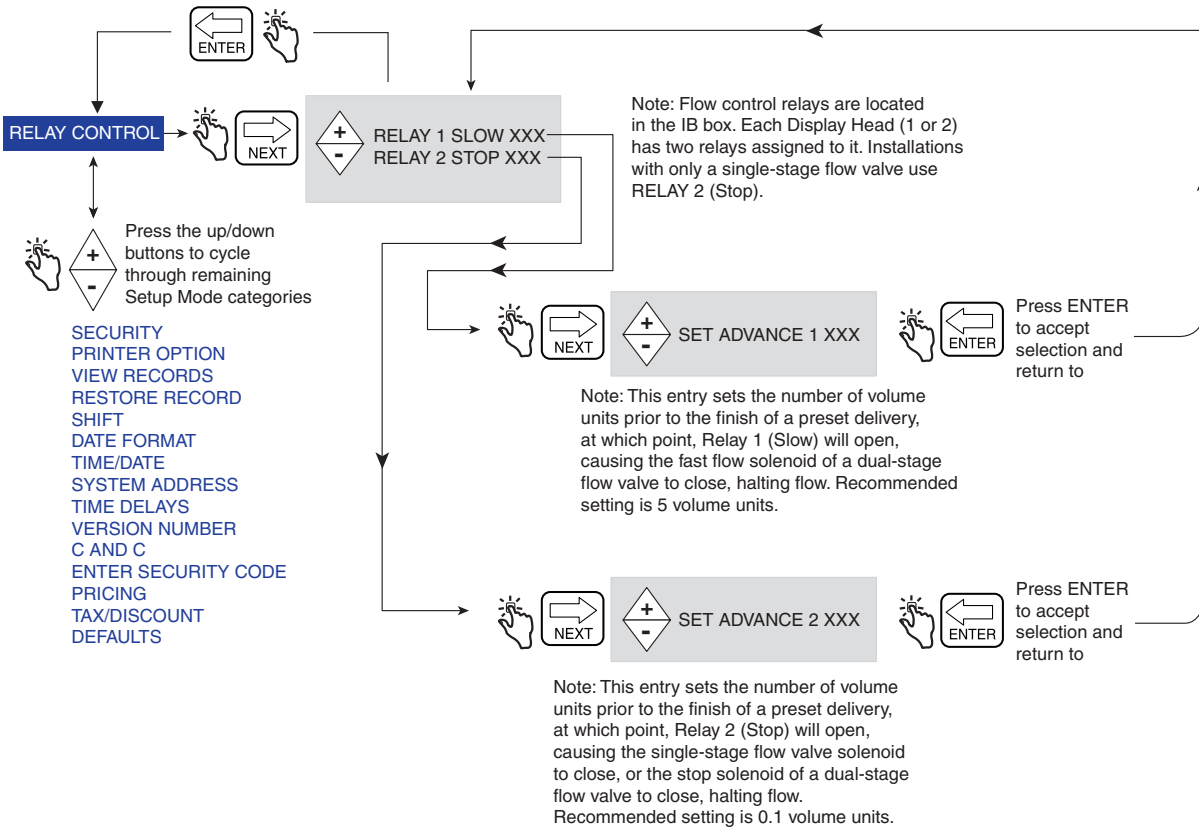

Figure 15. Relay Control Setup

NOTE:

See EMR4 Installation Guide, 577013-758 for Relay 1 (Slow) and Relay 2 (Stop) wiring connections to flow valve Solenoid 1 (Fast Flow) and Solenoid 2 (Stop).

SECURITY

NOTE: These menus do not appear until the SECURITY CODE feature is enabled in the C&C mode, described in Figure 51 of this manual.

Figure 16 illustrates the procedure for setting user pass codes and user access to certain setup parameters.

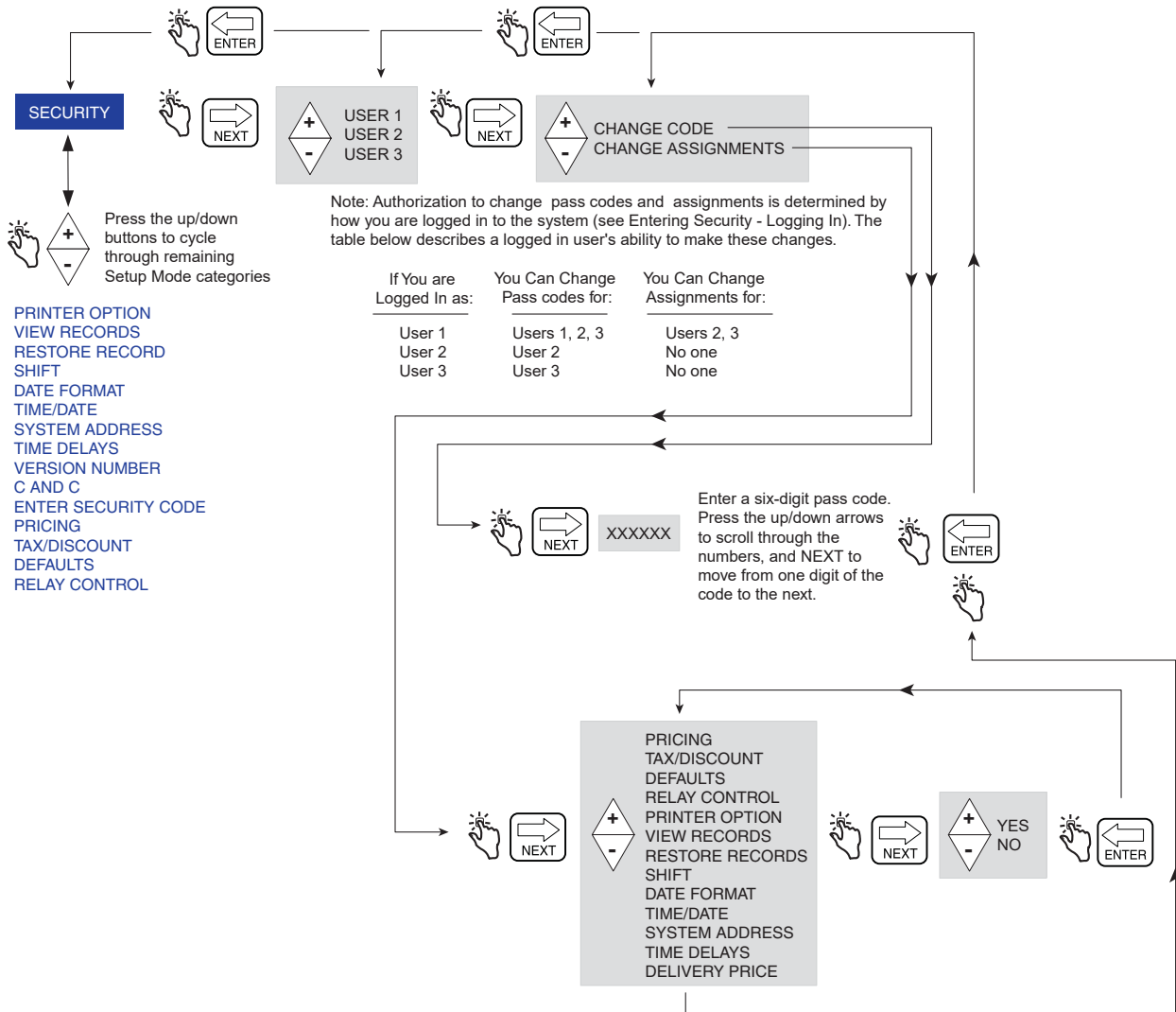

Note: All assignments are set to Yes (default) which lets all logged in users access the listed setup categories. When a selected setup category is set to No, access for the selected user is denied.

Figure 16. Passcode and Setup Access Setup

PRINTER OPTION

Figure 17 illustrates Printer Option setup in Setup Mode. This option lets you select a printer type and make the appropriate settings.

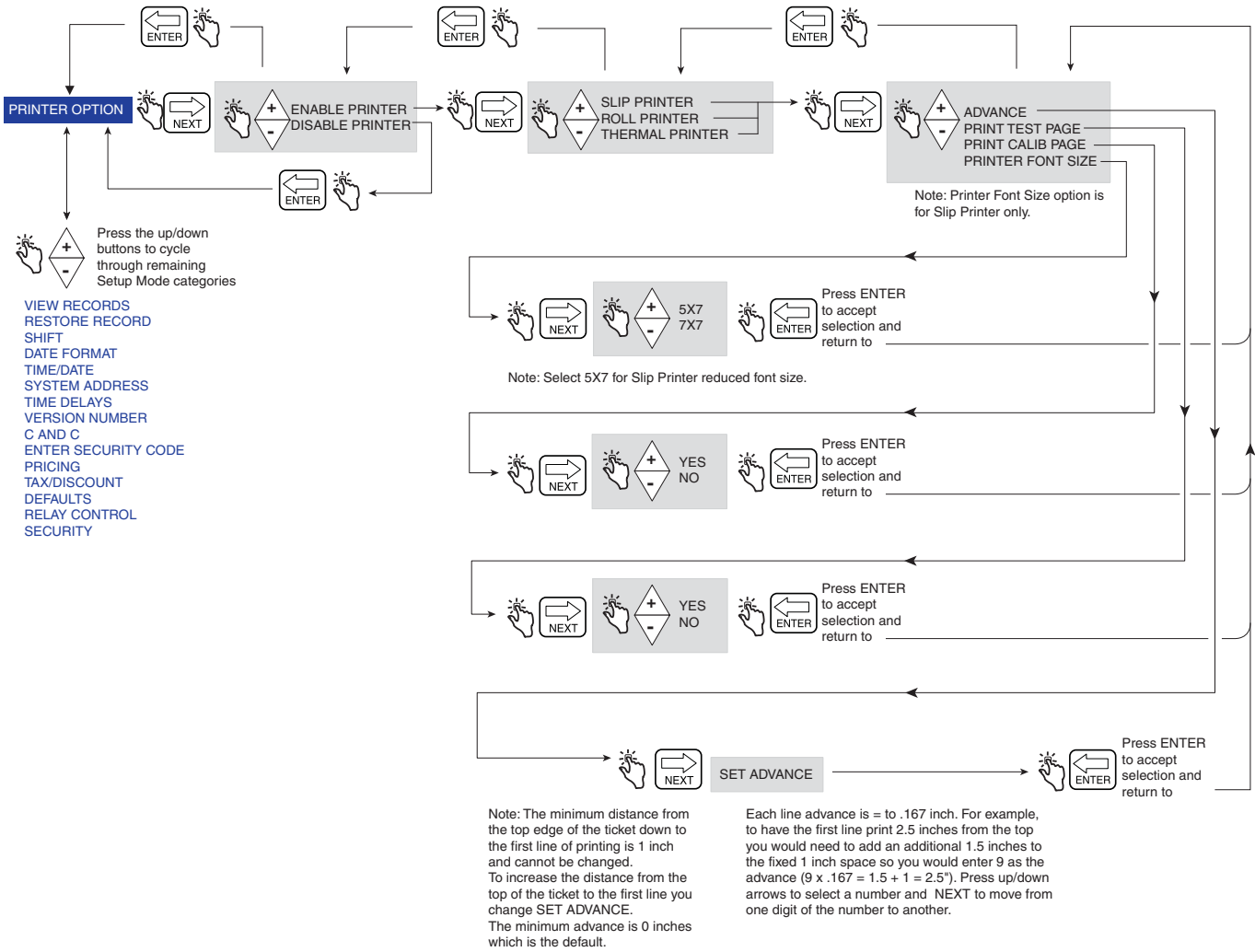

Figure 17. Printer Option Setup

An example of Printer Format 1 (Delivery Ticket Format), selectable in the Printer Option setup above, is shown in Figure 18.

NOTES:

1. The availability of certain printer labels is dependent on options selected.
2. The thermal printer is a customer supplied printer that is compatible with the HENGSTLER C-56 Printer Protocol and uses the following settings: 9600 baud, 1-Stop Bit, 8-Data Bits and No Parity.

Header (Up to 4 lines)	<pre>***** * Veeder-Root Co. * * EMR-4 * * * * * *****</pre>
Optional Date/time	<pre>START MMM-DD-YYYY HH:MM:SS FINISH MMM-DD-YYYY HH:MM:SS</pre>
Delivery Information	<pre>TICKET NUMBER 50399 PROD DSCRPT X PROPANE METER ID GENERIC 12345 TANK LOAD 100.0 TANK ID TANK DEFAULT CUSTOM FIELD1 CF1 CUSTOM FIELD2 CF2 CUSTOM FIELD3 CF3 CUSTOM FIELD4 CF4 CUSTOM FIELD5 CF5 CUSTOM FIELD6 CF6 CUSTOM FIELD7 CF7 TOTALIZER START 4007.155 TOTALIZER END 4017.155 VOLUME GAL START 0.0000 GROSS VOLUME FINISH 10.000 NET VOLUME FINISH 10.000 AVG FLOW RATE (GPM) 11.111 TEMP THIS DELIVERY 61.00 F VOLUME CORRECTED TO 60.0 F COEFFICIENT OF EXPANSION 0.00160</pre>
Price/Tax/Discount Information	<pre>PRICE/GALLON \$ 2.0000 SUBTOTAL \$ 20.000 %TAX T/D 1 % 10.0000 TAX/UNIT \$ 0.2000 AMOUNT \$ 2.0000 UNIT TAX T/D 2 \$ 10.0000 AMOUNT \$ 100.0000 SURCHARGE T/D 3 \$ 10.0000 AMOUNT \$ 10.0000 T/D SUBTOTAL \$ 132.00 %DISCOUNT T/D 4 % 10.0000 DISCOUNT/UNIT \$ -1.2200 AMOUNT SUB+T/D 1&2&3 \$ -13.2000 UNIT DISCOUNT T/D 5 \$ 10.0000 AMOUNT \$ -100.0000 T/D SUBTOTAL 5 \$ 18.8000 AMOUNT \$ -1.0000</pre>
Totals	<pre>FINAL PRICE/GALLON \$ 0.9800 TOTAL NON-TAX LINES \$ -94.00 TAX THIS DELIVERY \$ 91.80 GRAND TOTAL \$ 17.80</pre>
Trailer (Up to 3 lines)	<pre>→ You can count on us!</pre>

NOTE: Tax lines 1, 2, 3 are assigned to subtotal.

Figure 18. Delivery Ticket Format

VIEW RECORDS

Figure 19 illustrates View Records setup in Setup Mode.

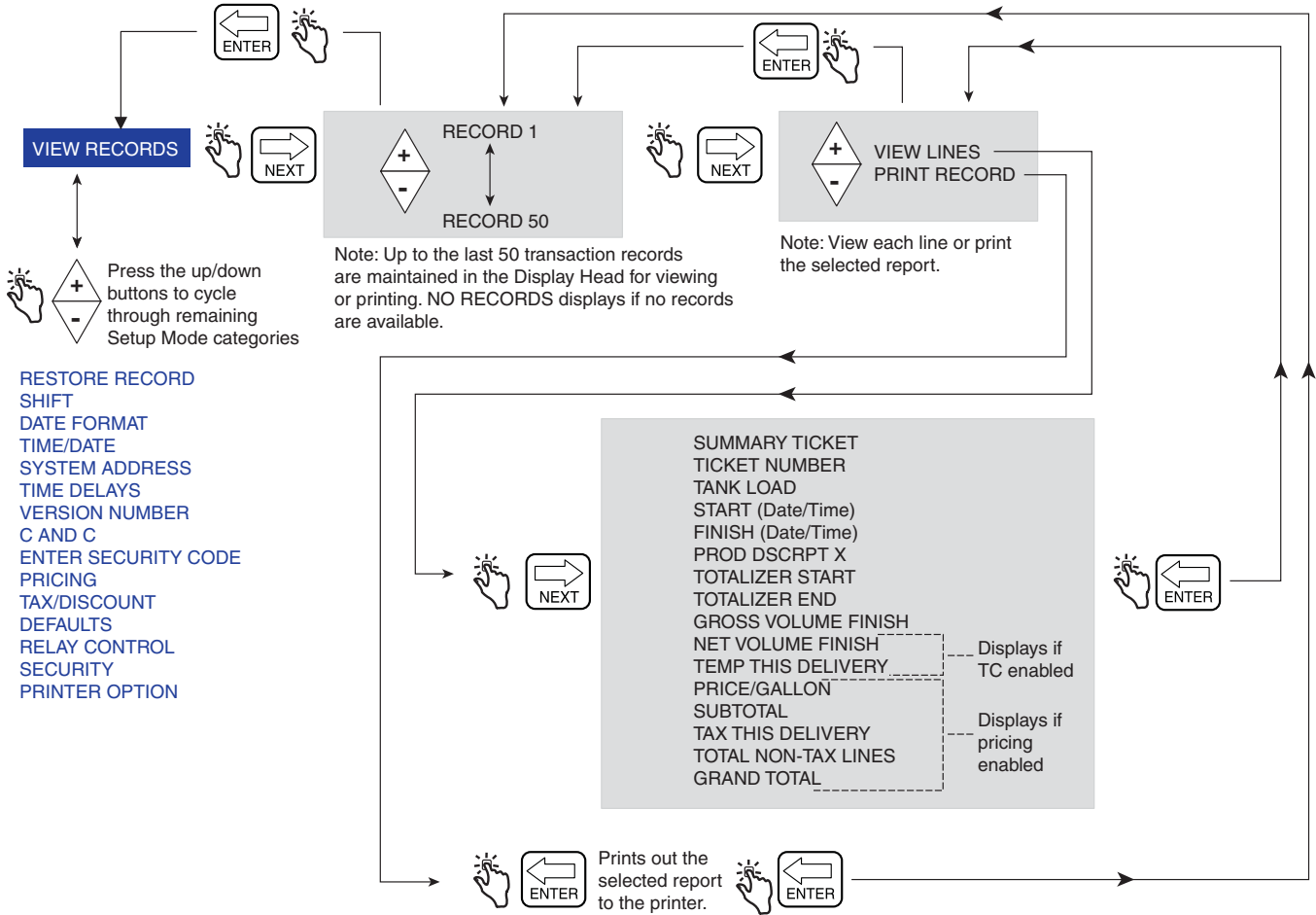

Figure 19. View Records Setup

RESTORE RECORDS

Figure 20 illustrates Restore Records procedure in Setup Mode.

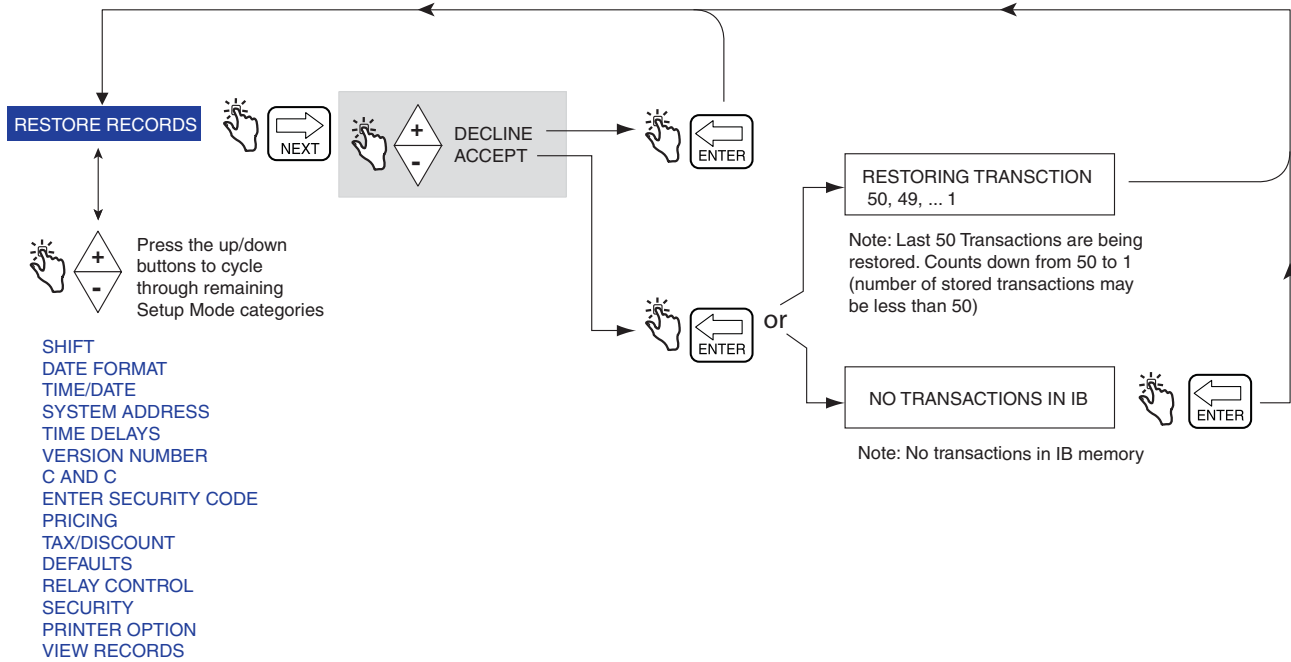

Figure 20. Restore Records Procedure

SHIFT

Figure 21 illustrates Shift setup and the Shift Report printing procedure in the Setup Mode.

Figure 22 illustrates the format of a shift report. When a shift report is selected, a separate report will be printed for each product if transactions for that product were recorded in the selected shift.

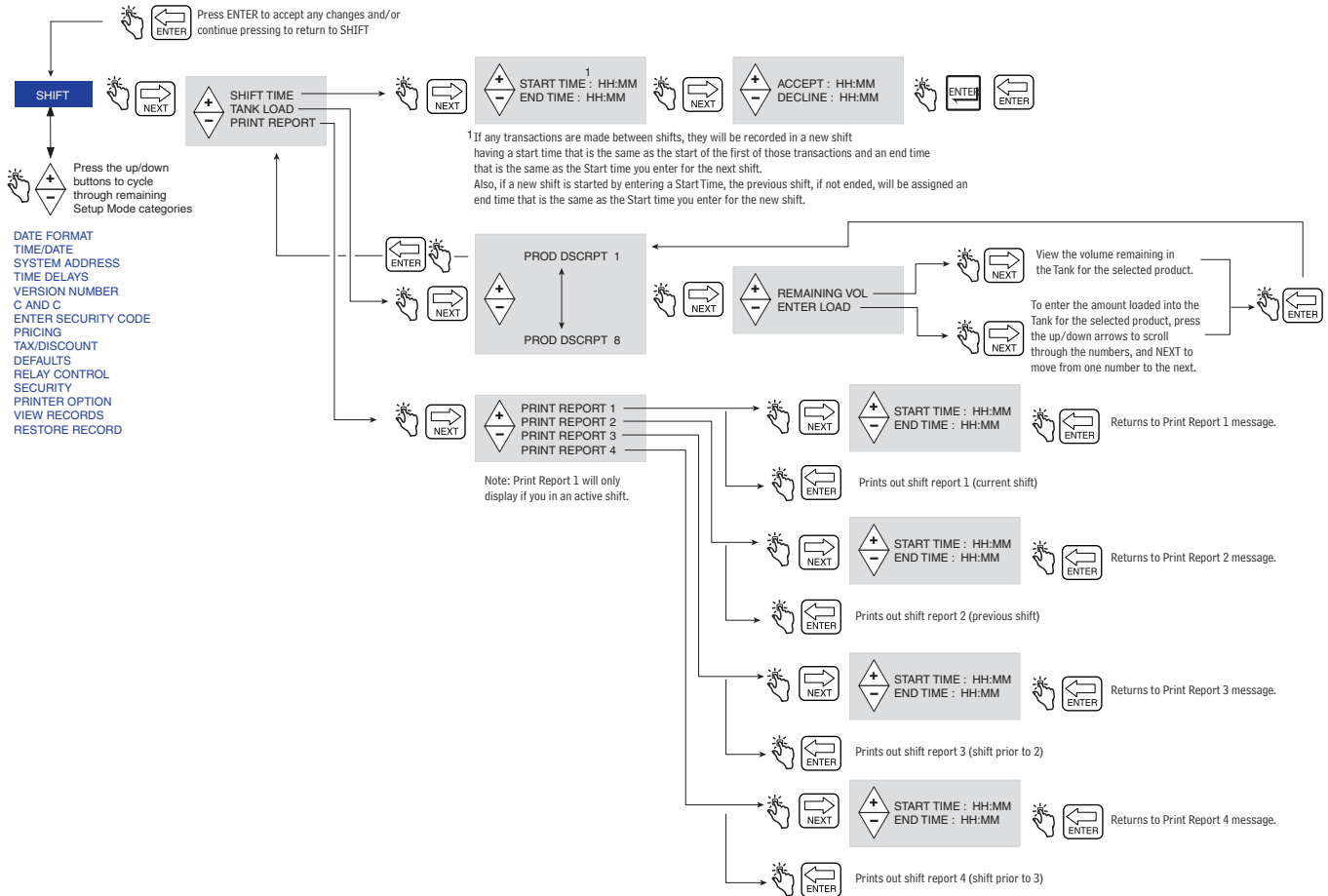

Figure 21. Shift and Shift Report Setup

Report Line Item	Source
SHIFT BEGIN:	Starting time/date of the shift
SHIFT END:	Ending time/date of the shift (only displayed if shift has ended)
PROD DSCRPT:	Name assigned to the product (e.g., gasoline)
METER ID:	Meter ID number assigned to the unit
BEGINNING VOLUME:	Total volume at the beginning of the shift (= ending volume of last shift)
LOADED VOLUME:	Compensated or uncompensated load entered in "Tanker Load" shift setup
ENDING VOLUME:	Volume remaining at the end of the shift (= beginning volume + loaded volume - total volume)
TOTAL GROSS VOLUME:	Uncompensated volume
SINGLE DELIVERIES:	Number of single deliveries during a shift
MULTIPLE DELIVERIES:	Number of multiple deliveries during a shift
TRANSFER DELIVERIES:	Number of transfer deliveries during a shift
ITEMIZED DELIVERIES:	Total number of itemized deliveries (= single deliveries + multiple deliveries)
TOTAL VOLUME:	Compensated (or uncompensated) volume (differs from total gross vol if the product is compensated)
TOTAL VOLUME NO PRICE:	Total volume that has no price code associated with it
TOTAL VOLUME PRICED:	Total volume that has a price code associated with it
TOTAL SALES W/O TD:	Total contribution of sales from the base price (w/o any T/D associated with it)
TOTAL TAX/DISCOUNT 1:	Total contribution of T/D 1 to the total sales
TOTAL TAX/DISCOUNT 2:	Total contribution of T/D 2 to the total sales
TOTAL TAX/DISCOUNT 3:	Total contribution of T/D 3 to the total sales
TOTAL TAX/DISCOUNT 4:	Total contribution of T/D 4 to the total sales
TOTAL TAX/DISCOUNT 5:	Total contribution of T/D 5 to the total sales
TOTAL TAX/DISCOUNT 6:	Total contribution of T/D 6 to the total sales
GRAND TOTAL:	Total sales during a shift (= total sales w/o T/D + Total T/D 1 + Total T/D 2 + Total T/D 3 + Total T/D 4 + Total T/D 5 + Total T/D 6)

Figure 22. Shift Report Format

DATE FORMAT

Figure 23 illustrates Date Format setup in Setup Mode.

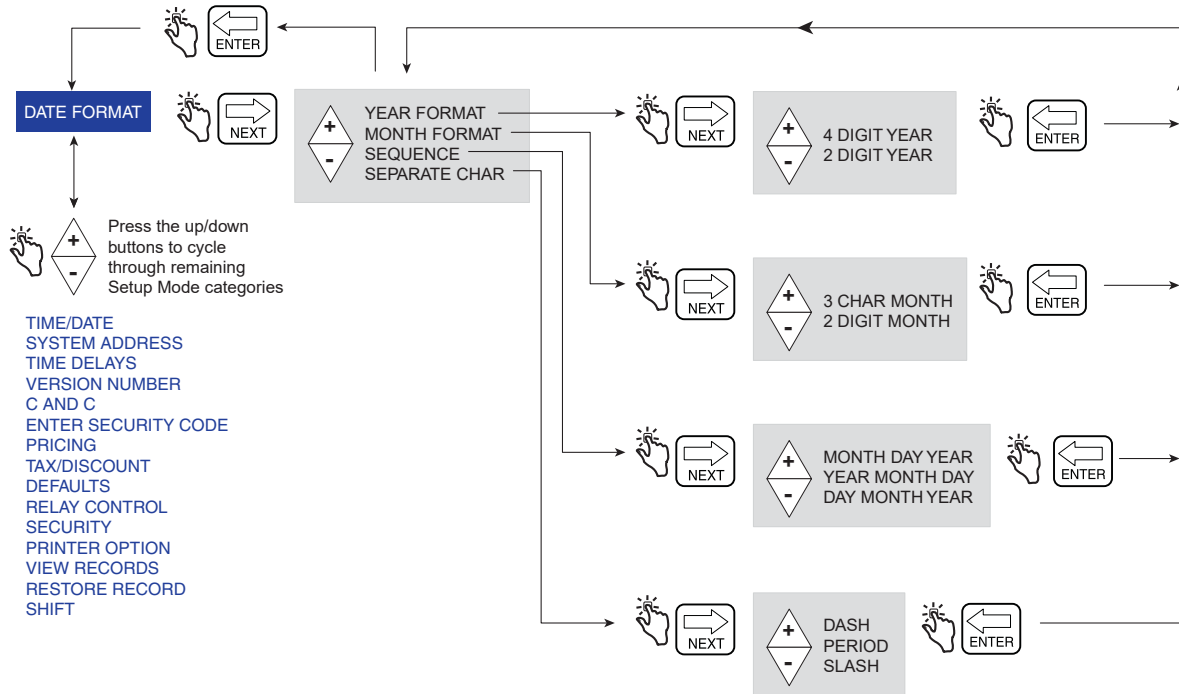

Figure 23. Date Format Setup

TIME/DATE

Figure 24 illustrates Time/Date setup in Setup Mode.

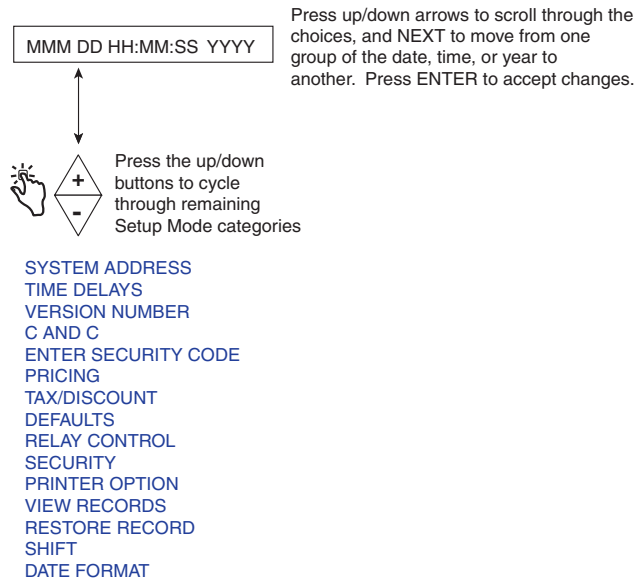

Figure 24. Date/Time Setup

SYSTEM ADDRESS

Figure 25 illustrates System Address setup in Setup Mode. The setups shown in Figure 26 through Figure 28 must be followed to set the addresses of each component connected to each IB.

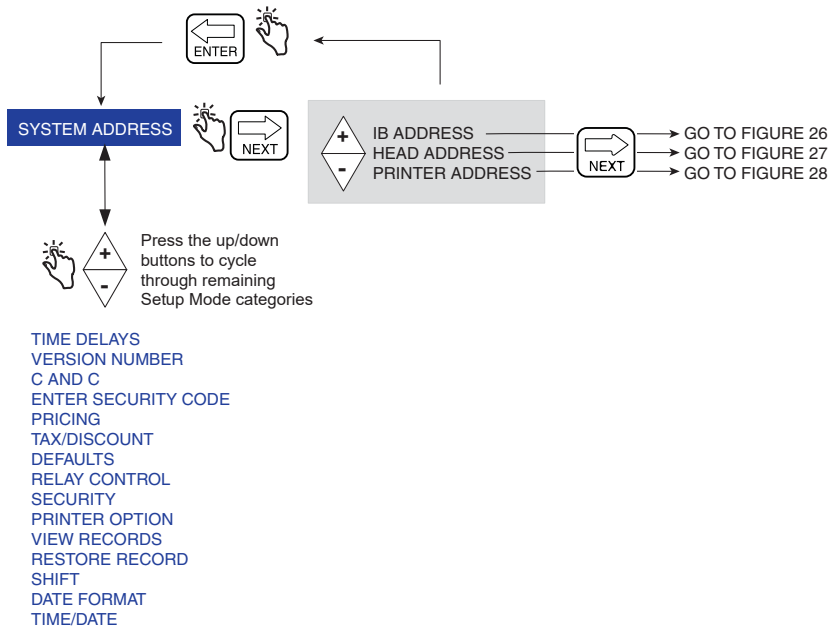

Figure 25. System Address Setup

IB Address Setup

Figure 26 illustrates the IB Address setup selections (the default IB address is 1). This setup is necessary only when there are more than one IBs connected in a network.

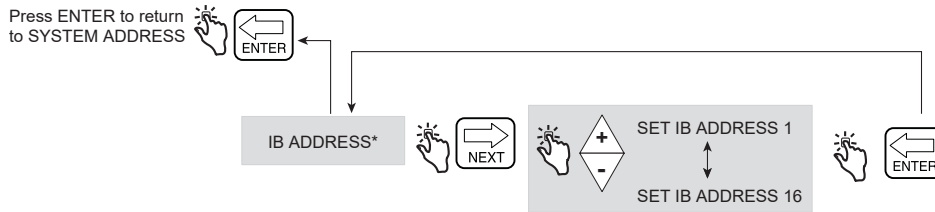

Figure 26. IB Address Setup

Head Address

Figure 27 illustrates Head Address setup choices (note Caution in figure below).

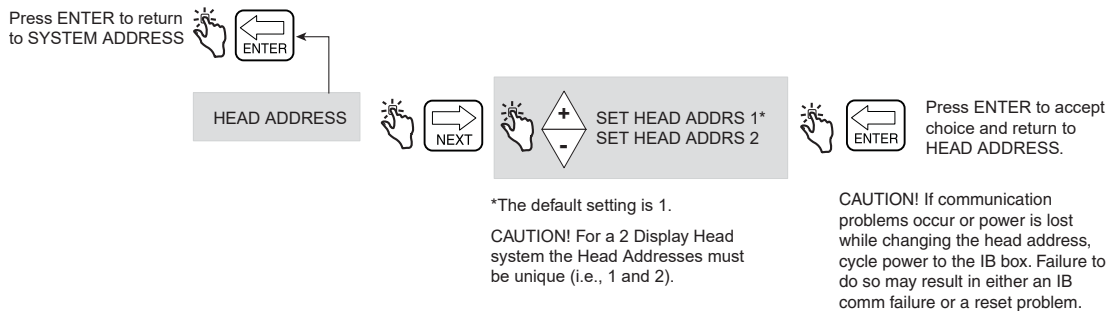

Figure 27. Head Address Setup

Initial Remote Display Setup

Connect both display heads to the IB box and apply power. In display head 2, enter **Setup Mode>System Address** and set the Head Address to 2. Wait 10 seconds for communication to be established. After 10 seconds, configure the IB address using either display head.

Put the Remote Display into the C&C Mode and enable it as a Remote Display (see Figure 45 on page 47). Press the NEXT button to select which Display Head will be the master, such as LOCAL EMR HEAD 1. Press ENTER until CONFIGURE I/O is displayed.

Exit the C&C Mode and return both Display Heads to the Volume Mode. Cycle power Off and On to the IB and verify Remote Display operation by simulating a delivery.

When using two Display Heads each with its own meter (i.e. not using Remote Display), and one Display Head is programmed to use multipoint calibration, the software does not require the other Display Head to use multipoint calibration; however, local W&M regulations may require it. See Figure 45 on page 47 for information on enabling Remote Display.

Printer Address

Figure 28 illustrates Printer Address setup choices.

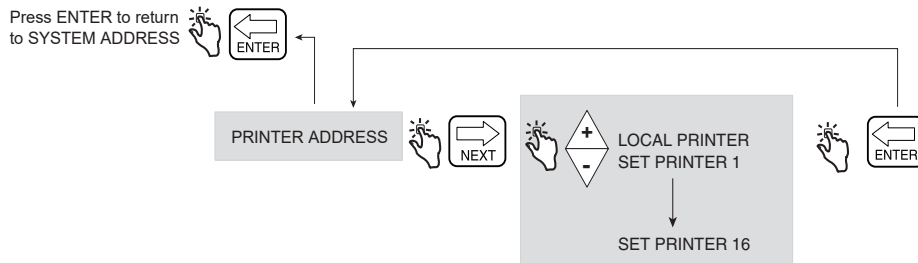

This menu selects the printer for this Display Head. Select a printer on Host IB (the IB to which this Display Head is wired), use Local Printer. Select a printer connected to an IB other than the one to which this Display Head is wired, select that IB's address. By default, the printer address is set to the host IB (the IB to which the Display Head is wired), and will be displayed as "LOCAL PRINTER". Printers on other IBs will display as "SET PRINTER nn", where nn is the IB address.

Figure 28. Printer Address Setup

TIME DELAYS

Figure 29 illustrates Time Delay setup in Setup Mode.

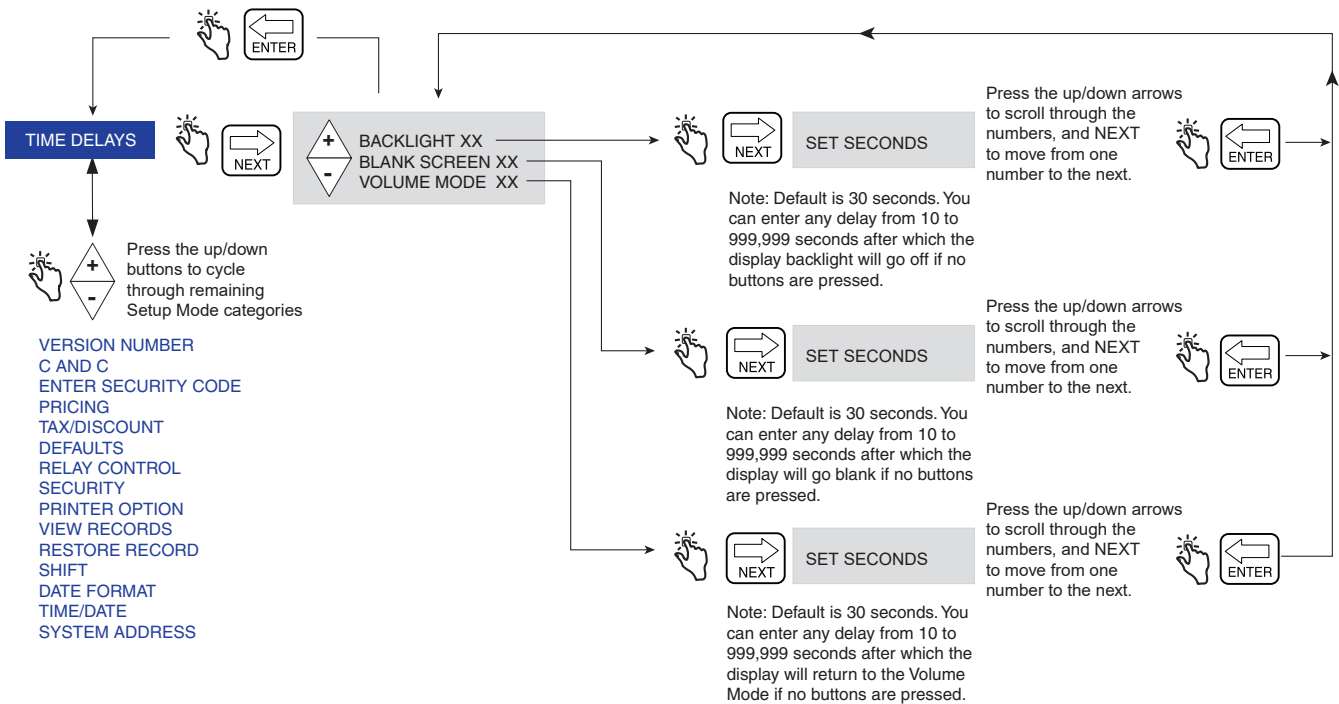

Figure 29. Time Delay Setup

VERSION NUMBER

Figure 30 illustrates Version Number viewer in Setup Mode.

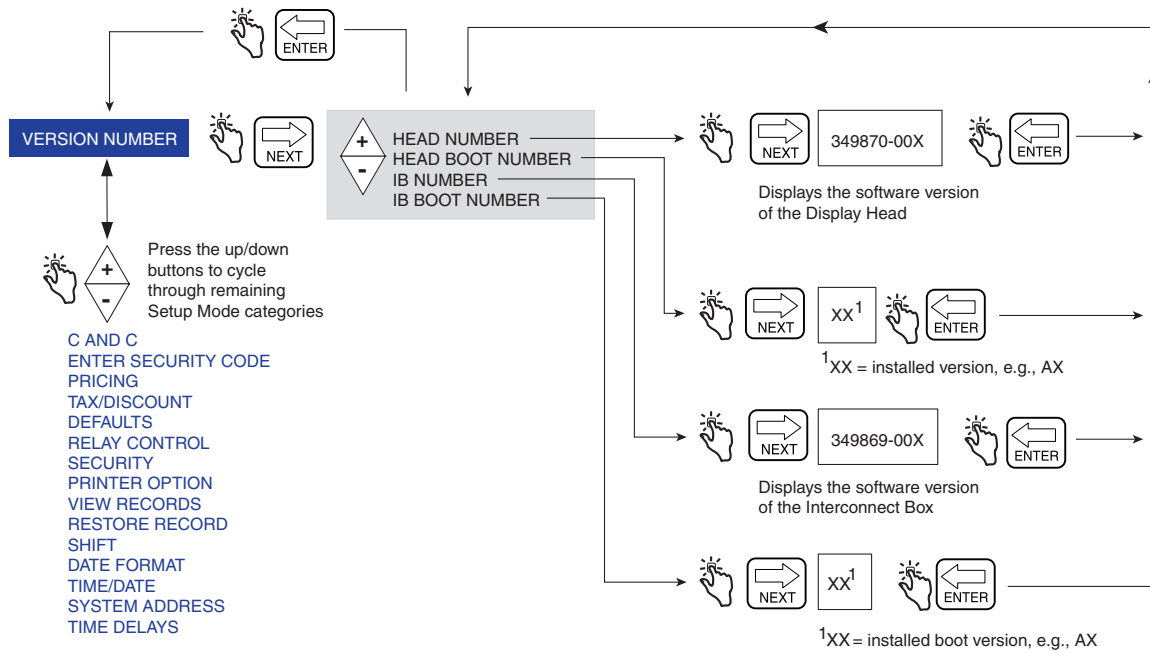

Figure 30. Version Number Viewer

C&C Mode

Initiating the C&C Mode

NOTE: To access C&C Mode you must first configure the display head as instructed in the EMR4 Application Guide (V-R P/N 577014-339).

1. Press MODE button until the indicator at the bottom of the display points to SETUP.
2. The first C&C Mode category, LANGUAGE, displays in the Descriptor Field. Press NEXT to enter Language Setup, or continue to press the ∇ button to step through the remaining C&C Mode Setup categories. Press NEXT to enter any category once it displays in the Descriptor Field.

C&C Mode Setup Categories

- **Language** setup - sets the volume, currency, setup, and printer label descriptions (see page 32).
- **Display Syntax** setup - sets the punctuation and decimal places for data displayed in the Preset, Register, and Totalizer Fields (see page 35).
- **Temperature** setup - sets optional temperature probe's units to Fahrenheit or Celsius (see page 36).
- **Fuel Source** setup - sets the meter ID, meter input signal type, and product descriptions (see page 37).
- **Meter Calibration** setup - sets the calibration of the meter by product using one of three methods (see page 44).
- **Configure I/O** setup - enables various inputs/outputs such as Emergency Stop and Remote Start & Stop output (see page 47).
- **OEM Message** setup - lets you enter the start up OEM message (see page 47).
- **Delivery Options** setup - This option lets you enable or disable price changing within the Delivery State as per your regulatory requirements. In this setup you also select coefficient (of expansion) or density as the temperature compensation method for deliveries, enable delivery timeout, enable Tank ID, enable Custom fields, enable Tank Load and enable E04 encoder error (Gross volume and Temperature on Ticket fields also visible when temperature probe connected to EMR Head). Also you can enable / disable Gross Preset, Gross Viewable, Multicalibrate 0.25% Diff and Multiple Delivery (see page 48).
- **Report Formats** setup - lets you print or compose formats for the Delivery Ticket and Shift Report (see page 49).
- **Restart** setup - allows you to reboot while maintaining current setups, or to reboot and reset all setup selections to factory default settings as well as removing all current transaction records (see page 52).
- **Security Code** setup - allows you to enable security code protection to limit access to selected Setup Mode categories (see page 53).

Instructions for setting up the C&C Mode setups are shown in the figures that follow. In some cases multiple figures are used to explain sub-procedures within a C&C Mode category. Once you have entered a C&C Mode category (pressing NEXT), do not press the \triangle or ∇ buttons in that setup if you do not intend to change a value, because when you press ENTER, the change, even if unintended, will be accepted. If you want to view setup settings without making changes, press NEXT to move 'into' a category's setup and ENTER to 'back out' of the setup.

IMPORTANT! If in a C&C Setup you press ENTER too many times, you may ‘back’ out of the C&C Mode and end up somewhere in the Setup Mode menu. To reenter C&C Mode, scroll around as shown below:

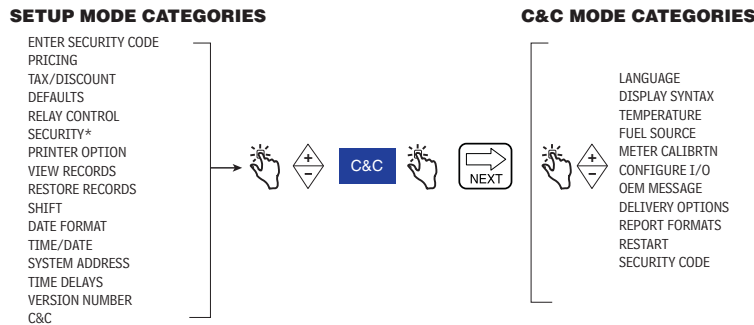

LANGUAGE

Figure 31 illustrates Language setup in C&C Mode.

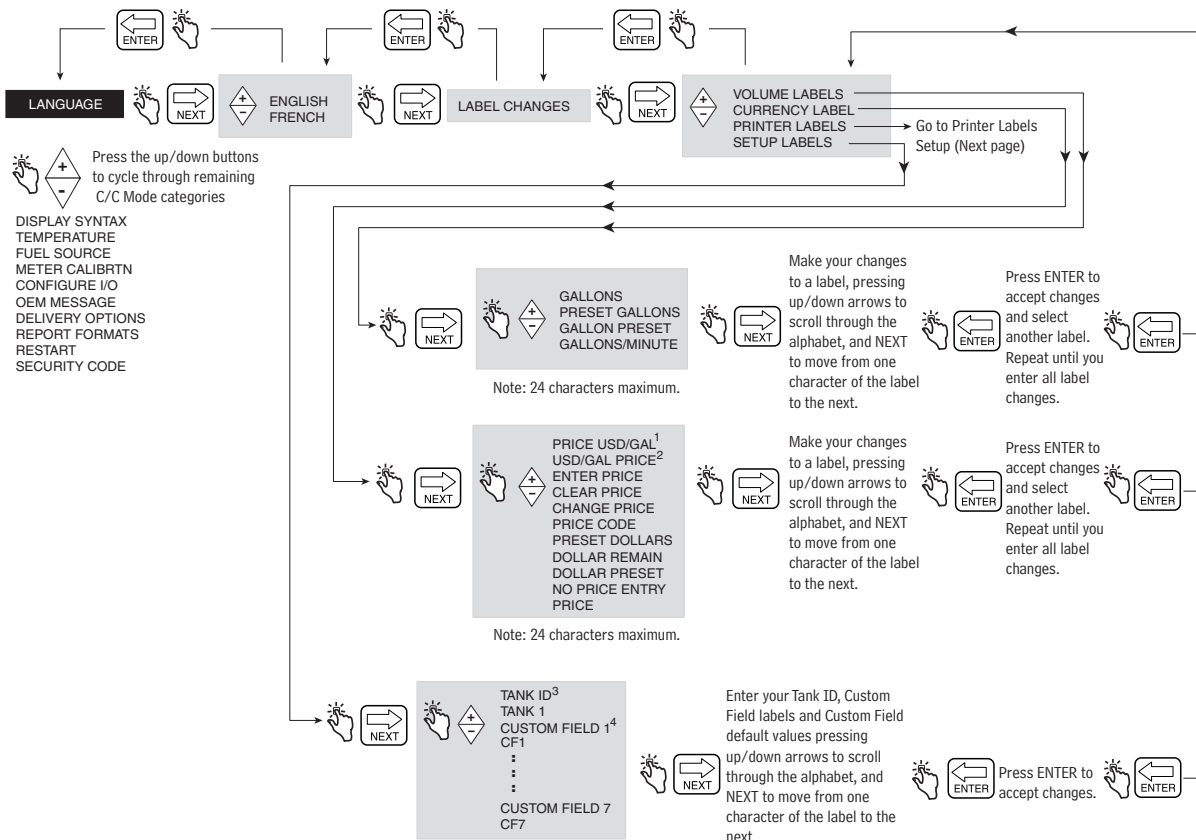

Footnotes:

1. Format is Price (space) (Price Unit). Price Unit is defined as Currency Unit / Volume Unit. For English the default is USD/GAL and for French it is EUR/L.
2. Format is (Price Unit) (space) PRICE. Price Unit must be the same as selected for PRICE (i.e., USD/GAL or EUR/L). Please use standard currency / volume units to keep the display format as regulations require. Up to 3 characters for Currency and 3 characters for Volume Units may be used.
3. The default label for Tank ID is Tank 1. For each transaction the Tank ID is stored and may be printed. The default label for Tank ID is Tank 1. For each transaction the Tank ID is stored and may be printed.
4. The default label for Custom Field 1 – 7 is CF1 – CF7. For each transaction the Custom Field is stored and may be printed.

Figure 31. Language Setup

Printer Labels

Figure 32 illustrates Printer Label defaults used in Delivery Tickets and Shift Reports. You use this setup to edit the text of any printer label, e.g., to change the label START to BEGIN (ref. Figure 48 to select the printout's format). Figure 33 provides additional information for selecting Tax and Discount printer labels.

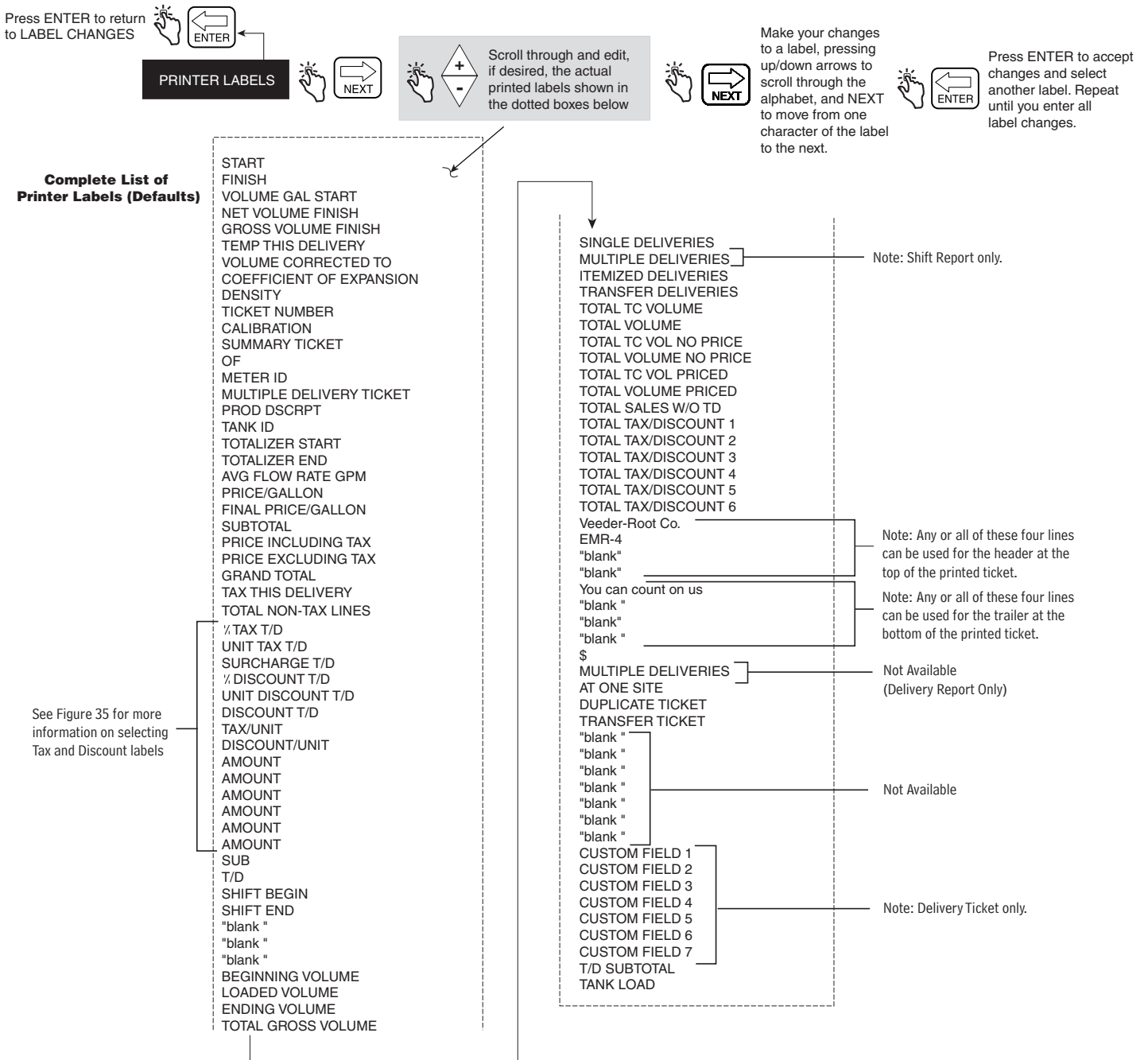

Figure 32. Printer Labels Setup

Group Code	Designations in software of Adjacent Labels	Printed Tax & Discount Labels
A1	TAX_PERCENT1	%TAX T/D
B1	TAX_PER_VOLUME1	UNIT TAX T/D
C1	TAX_SURCHARGE1	SURCHARGE T/D
D1	DISCOUNT_PERCENT1	%DISCOUNT T/D
E1	DISCOUNT_PER_VOLUME1	UNIT DISCOUNT T/D
F1	DISCOUNT_SURCHARGE1	DISCOUNT T/D
A2	TAX_PERCENT2	T/D SUBTOTAL
D2	DISCOUNT_PERCENT2	TAX/UNIT
A3	TAX_PERCENT3	DISCOUNT/UNIT
B2	TAX_PER_VOLUME3	AMOUNT
C2	TAX_SURCHARGE3	AMOUNT
D3	DISCOUNT_PERCENT3	AMOUNT
E2	DISCOUNT_PER_VOLUME3	AMOUNT
F2	DISCOUNT_SURCHARGE3	AMOUNT

Tax and Discount labels automatically print in 2 or 3 line groups. The (**A1**, **B1**, etc.) to the left of the software designations indicate the label's group and line position (e.g. A1 prints first, A2 on next line, etc). The groups and printing positions are:

A1	B1	C1	D1	E1	F1
A2	B2	C2	D2	E2	F2
A3			D3		

(Only the A and D groups have 3 lines)

For example, if in any of your price codes, you assigned a percentage tax to the base price, the A group would indicate this adjustment and would print as:

%Tax T/D	%	XX.XXXX	(A1)
Tax/Unit	\$	X.XXXX	(A2)
Amount	\$	XX.XXXX	(A3)

Figure 33. Tax and Discount Label Group Codes

DISPLAY SYNTAX

Figure 34 illustrates Display Syntax setup in C&C Mode. Table 1 shows the EMR4 display syntax defaults.

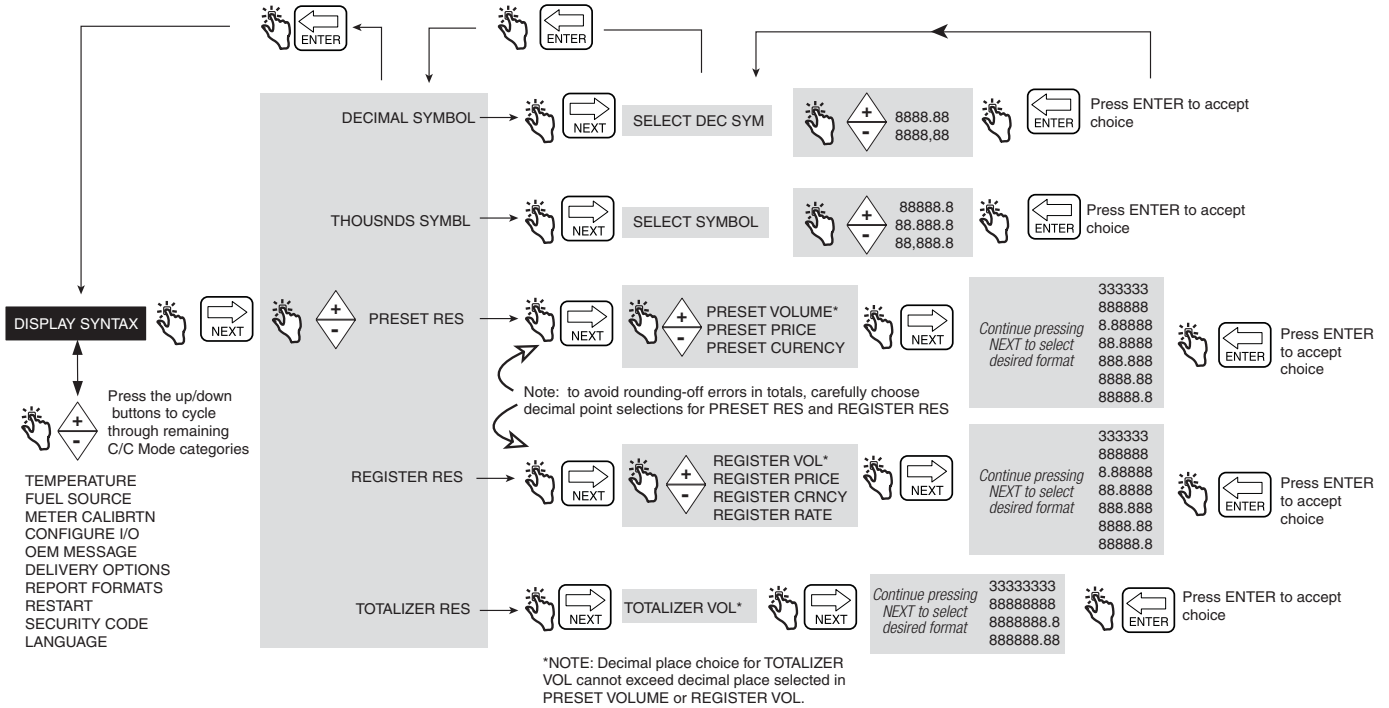

Figure 34. Display Syntax Setup

Table 1 - EMR4 Default Syntaxes

Item	Default Syntax
Decimal Symbol	8,888.88
Thousands Symbol	88,888.8
Preset Res	
Preset Volume	33,333.3
Preset Price	3.33
Preset Currency	3,333.33
Register Res	
Register Volume	33,333.3
Register Price	3.33
Register Currency	3.33
Register Rate	333,333
Totalizer Res	
Totalizer Volume	333 3333.3

TEMPERATURE

Figure 35 illustrates Temperature Probe's setup in C&C Mode.

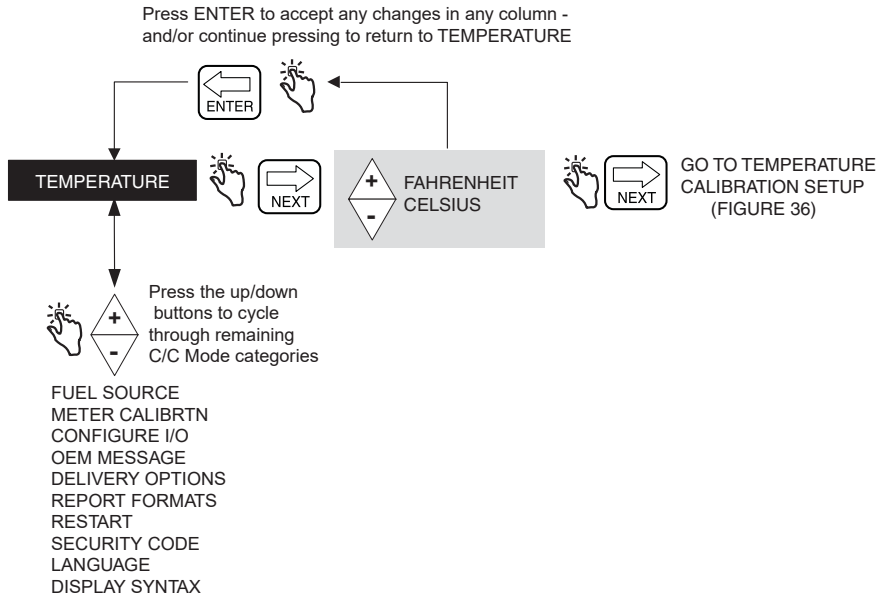

Figure 35. Temperature Setup

Temperature Calibration

Figure 36 illustrates Temperature Probe Calibration setup choices.

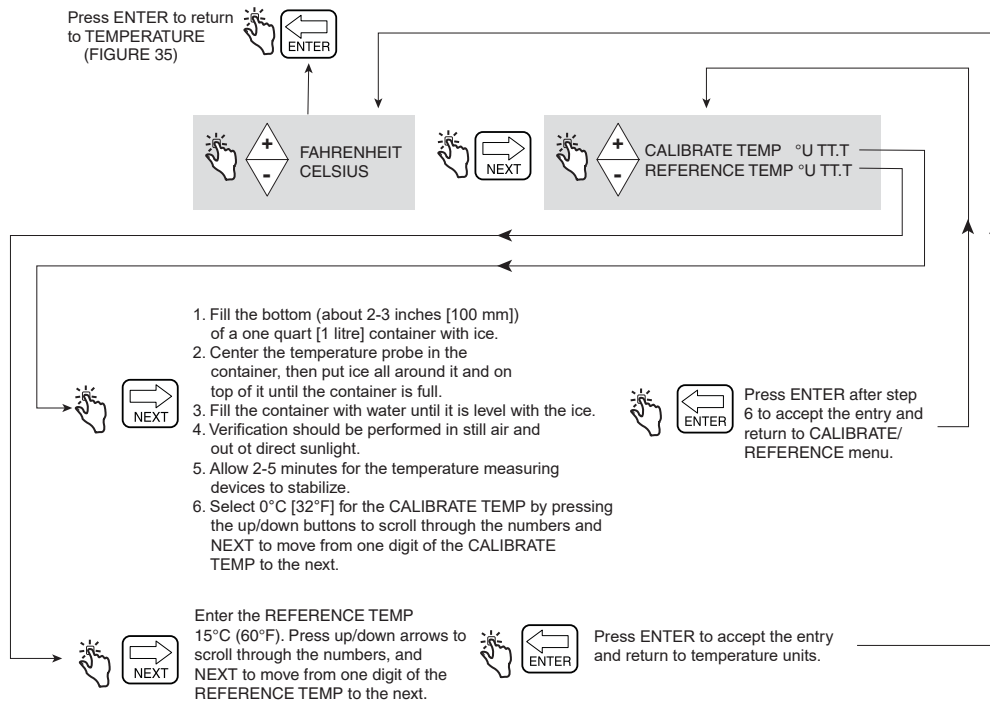

Figure 36. Temperature Calibration Setup

FUEL SOURCE

Figure 37 illustrates Fuel Source setup in C&C Mode. If you are going to make temperature compensated deliveries, before performing Fuel Source setup, you must select either coefficient (of expansion) or density as the temperature compensation method in Delivery Options setup (see Figure 47).

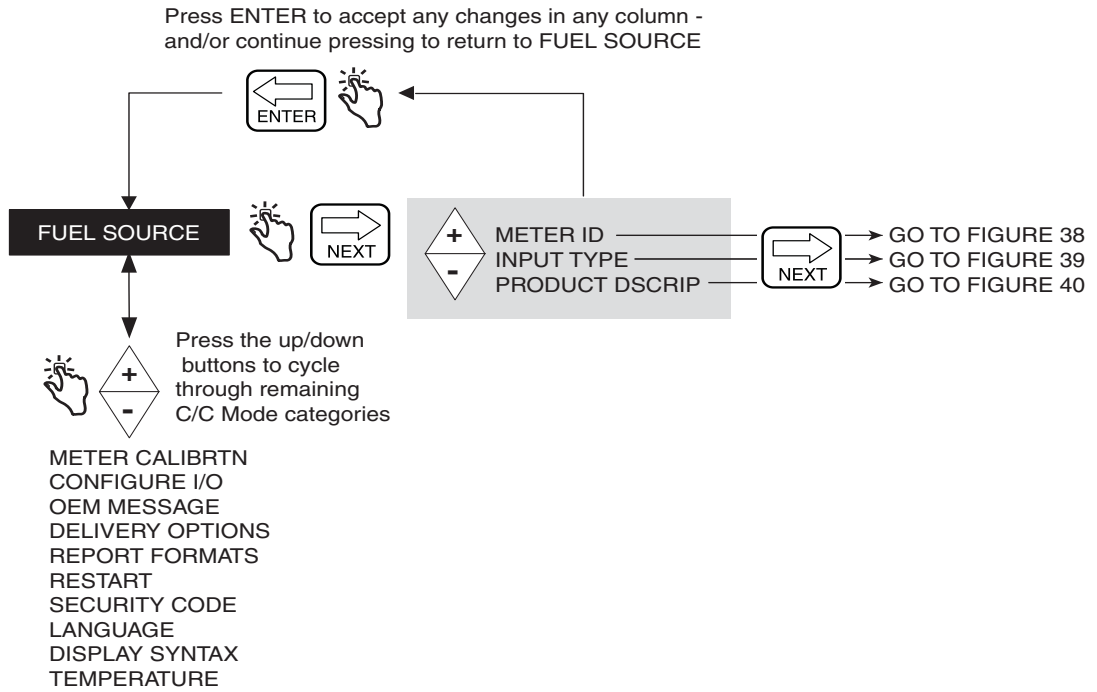

Figure 37. Fuel Source Setup

Meter ID

Figure 38 illustrates Meter ID setup choices.

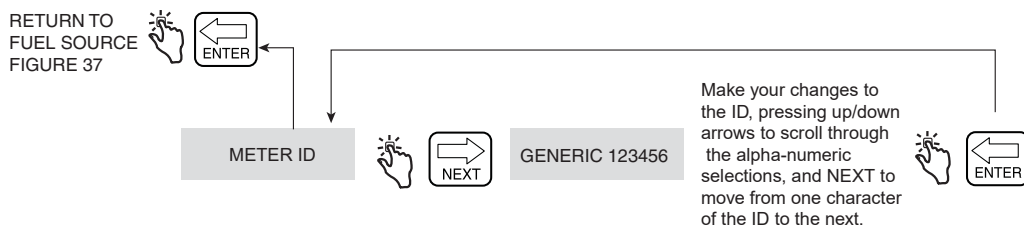

Figure 38. Meter ID Setup

Input Type

Figure 39 illustrates Input Type setup choices. Quadrature is the default input type.

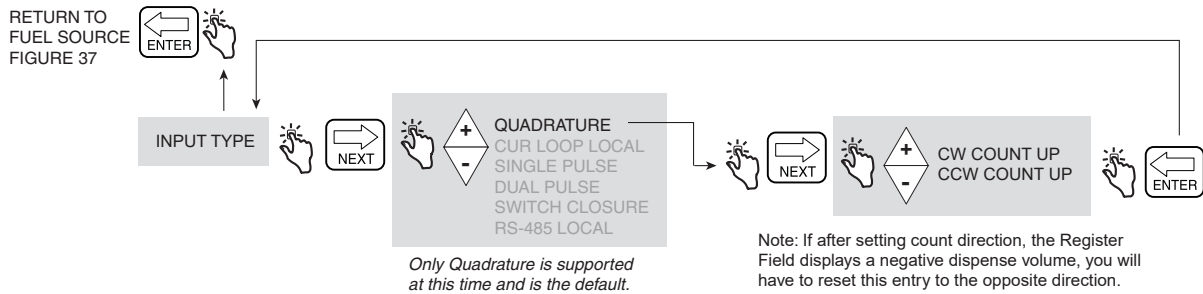

Figure 39. Input Type Setup

Product Description

Figure 40 illustrates Product Description setup choices. You can assign up to eight products for the EMR4. Each product has a type, a name, and a temperature compensation factor. Thermal compensation for all products is calculated by either thermal coefficient or density, which you select in Delivery Options Setup (page 48).

Entering a Custom Name for a Product Type

There are eight default Product Types in the EMR4. If you select one of the default Product Types you do not have to accept a default Product Name. For example, if you wanted to assign Jet Fuel to Product 1, select Jet A as the Product Type for Product 1 and change the Product Name from Jet A to Jet Fuel.

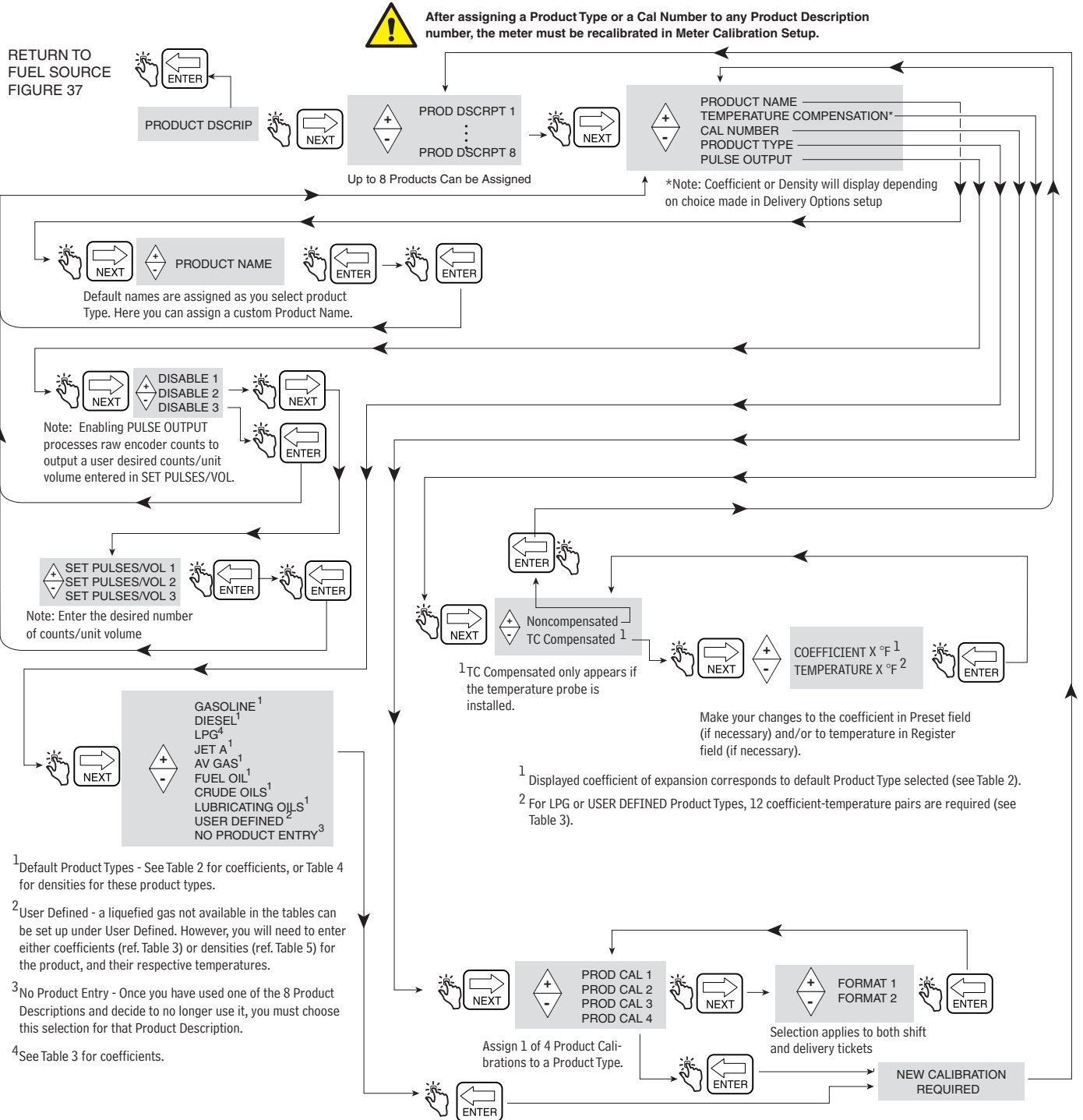

Figure 40. Product Description Setup

TEMPERATURE COMPENSATION METHOD - COEFFICIENT OF EXPANSION

Table 2 - Product Temperature/Coefficient of Expansion Defaults

Product	Coefficient °C	Coefficient °F	Default Density at 15°C ¹	OIML R63 Table
Gasoline	0.00126	0.00070	737 kg/m ³	54B
Diesel	0.00081	0.00045	849 kg/m ³	54B
Jet A	0.00090	0.00050	820 kg/m ³	54B
Aviation gas	0.00135	0.00075	704 kg/m ³	54B
Fuel Oil	0.00081	0.00045	849 kg/m ³	54B
Crude Oil	0.00085	0.00047	940 kg/m ³	53A
Lubricating Oils	0.00085	0.00047	887 kg/m ³	53D

¹Acceptable temperature compensation range: -40°C to +70°C.

Temperature compensated volume changes for specific products are determined using the formula:

$$V_o = V_t + V_t [C_{oe} (15^\circ\text{C} - t)]$$

Coefficient (C_{oe}) values may be modified to meet specific fuel/product specifications. The factor "t" is the measured fuel temperature. For example, use the procedure described in Figure 40 on page 39 to change the default coefficient of expansion for diesel from 0.00081 to 0.00083. To calculate temperature compensated volume the coefficient of expansion (C_{oe}) is now equal to 0.00083.

Table 3 - Temperature/Coefficient of Expansion Defaults for Propane¹

Entry No.	Temp (°C)	Default Coefficient	Temp (°F)	Default Coefficient
1	-26.1	0.00257	-15	0.00143
2	-20.6	0.00261	-5	0.00145
3	-15.0	0.00265	5	0.00147
4	-9.4	0.00270	15	0.00150
5	-3.9	0.00275	25	0.00153
6	1.7	0.00279	35	0.00155
7	7.2	0.00284	45	0.00158
8	15.0	0.00288	59	0.00160
9	23.9	0.00293	75	0.00163
10	29.4	0.00302	85	0.00168
11	35.0	0.00306	95	0.00170
12	40.6	0.00310	105	0.00172

¹Note: for other liquefied petroleum gases modify the coefficient of expansion defaults to their proper values in accordance with ASTM-IP Tables.

TEMPERATURE COMPENSATION METHOD - DENSITY RATIOS FOR LIQUID PETROLEUM PRODUCTS

Table 4 - Minimum & Maximum Product Densities at 15°C¹

Product	Min. Density (kg/m ³)	Max. Density (kg/m ³)	EMR4 Default Density (kg/m ³)	Canadian Default Density (kg/m ³)	API OIML R63 Table
Gasoline	600.0	770.0	737.0	730.0	54B
Diesel	838.6	1200.0	849.0	840.0	54B
Jet A	760.0	860.0	820.0	800.0	54B
Aviation Gas	600.0	770.0	704.0	710.0	54B
Fuel Oil	838.6	1200.0	849.0	840.0	54B
Crude Oils	610.5	1075.0	940.0	940.0	53A
Lubricating Oils	750.0	1164.0	887.0	880.0	54D

¹Acceptable temperature compensation range: -40°C to +70°C. Temperature compensated volume changes for specific products are determined using the formula:

$$V_o = V_t (\rho_t / \rho_o)$$

where: V_t = uncompensated gross volume

V_o = calculated temperature compensated volume

ρ_t / ρ_o = ratio of density at measured temperature to density at base temperature

The ratio of density is calculated after inserting the appropriate constants into the equation below:

$$\rho_t / \rho_o = e^{-\lambda}$$

Where: $\lambda = -\alpha_o (t - 15) [1 + \alpha_o (0.8) (t - 15)]$

t = measured temperature

$$\alpha_o = K_0 / \rho_o^2 + K_1 / \rho_o \text{ or } \alpha_o = A + B / \rho_o^2$$

Notes:

The ratio of density is equation 4.16 from page 9 of the PTB-A 5 Measuring Systems for Liquids other than Water - June 1999 edition.

Setting factor pairs used to calculate α_o above (K_0 and K_1 or A and B) are taken from Table 4.2 on page 10 of the PTB-A 5 Measuring Systems for Liquids other than Water - June 1999 edition.

Procedure to Revise Default Product Densities

In countries or regions that have standards for product density, the EMR4 can be setup to use a specific density at the reference temperature. To meet the local standard, use the following procedure to match the product density used by the EMR4 to the required density value. See Table 4 for Canadian default product densities.

In Table 4 on page 41, a list of alternate default densities is provided only as a reference. To change the default density, the user must have access to the Configuration & Calibration mode (C&C) of the EMR4 in order to revise the density for a given product at the reference temperature. Typically the reference temperature of either 15°C or 60°F is used to calculate temperature compensated volume. Note that the Thermoprobe must be connected to the EMR4 in order to measure product temperature.

1. Set the temperature mode to Celsius or Fahrenheit as shown in Figure 35, Temperature Setup.

C&C→TEMPERATURE→**CELSIUS** (e.g., change from Fahrenheit to Celsius)

Use the NEXT (→) key to navigate across the menu and the up/down keys to view each selection. Use the ENTER key to return to the main menu.

2. The reference temperature is the temperature at which the net volume will be compensated (TC). The net volume is calculated from the gross volume adjusted for the difference between the fluid temperature and the reference temperature. To revise the reference temperature, follow the steps as shown in Figure 36, Temperature Calibration Setup. Typically the reference temperature is set to 15°C when using Celsius or 60.0°F when using Fahrenheit.

C&C→TEMPERATURE→CELSIUS→REFERENCE TEMP→**15°C** (e.g., change from 60°F to 15°C)

3. In order to change the density for a given product, the EMR4 has to be set to the density mode and temperature compensation must be enabled as described in Figure 47, Delivery Options.

C&C→DELIVERY OPTIONS→TEMP COMPENSATION→**DENSITY** (e.g., change from Coefficient to Density) <Enter to return to main menu>

4. After completing the above 3 steps, change the default density value for up to eight specific products as described in Figure 40, Product Description Setup.

C&C→FUEL SOURCE→PRODUCT DSCRIP→PRODUCT DSCRIPT 1→TEMPERATURE COMPENSATION→TC COMPENSATED→DENSITY→**730.0** (e.g., change default gasoline density 737.0 to 730.0)

Use the navigation keys to change the density value. Use the ENTER key to accept the new value and return to the main menu.

Continue to setup the EMR4 according to the instructions in the Setup and Operation Manual.

- NOTICE** 5. The EMR4 calculation methods used comply with OIML R 117, Dynamic measuring systems for liquids other than water, <https://www.oiml.org/en>.

TEMPERATURE COMPENSATION METHOD - DENSITY RATIOS FOR LIQUEFIED PETROLEUM PRODUCTS

Table 5 - 12 Temperature/Density Pairs^{1,2}

Entry No.	Temp (°C)	Temp (°F)	Propane Density (Default) (kg/m ³)	Butane Density (Reference) (kg/m ³)
1	-26.1	-15	563.0	629.0
2	-20.6	-5	558.0	623.0
3	-15.0	5	551.0	617.0
4	-9.4	15	545.0	611.0
5	-3.9	25	537.0	606.0
6	1.7	35	529.0	599.0
7	7.2	45	522.0	594.0
8	15.0	59	510.0	585.0
9	23.9	75	496.0	574.0
10	29.4	85	487.0	568.0
11	35.0	95	478.0	562.0
12	40.6	105	469.0	555.0

¹For other liquefied gases modify the density defaults to their proper values in accordance with ASTM-IP Tables.

²The EMR4 calculates temperature compensated volume using the 12 density pairs from Table 5 above in the following formula:

$$V_o = V_t (\rho_t / \rho_o)$$

where: V_t = uncompensated gross volume

V_o = calculated temperature compensated volume

ρ_t / ρ_o = ratio of density at measured temperature to density at base temperature

The ratio of density is calculated after inserting the appropriate P constants into the equation below:

$$\rho_t / \rho_o = 1 + (-P_1 / \rho_o + P_2)(t - 15^\circ\text{C}) + (-P_3 / \rho_o + P_4)(t - 15^\circ\text{C})^2$$

Notes:

The ratio of density is equation 4.21 from page 10 of the PTB-A 5 Measuring Systems for Liquids other than Water - June 1999 edition.

Setting factors (P_1 , P_2 , P_3 and P_4) used to calculate ρ_t / ρ_o above are taken from Table 4.3 on page 11 of the PTB-A 5 Measuring Systems for Liquids other than Water - June 1999 edition.

METER CALIBRATION

Figure 41 illustrates Meter Calibration setup in C&C Mode.

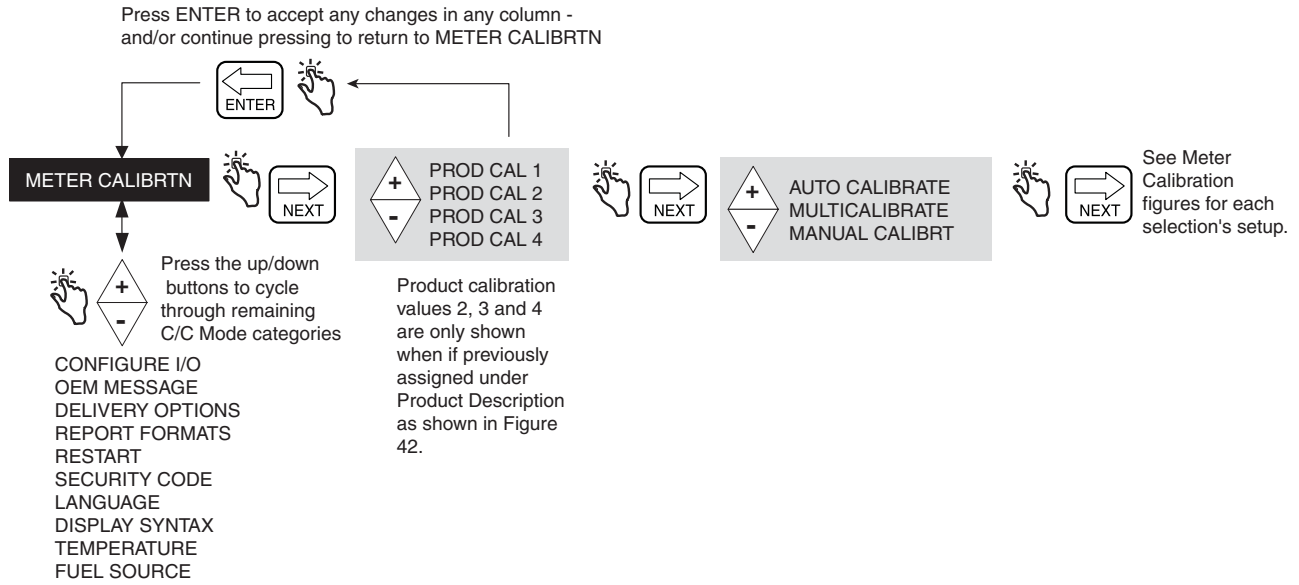

Figure 41. Meter Calibration Setup

Auto Calibrate

Figure 42 illustrates meter Auto Calibration (single point) setup procedure.

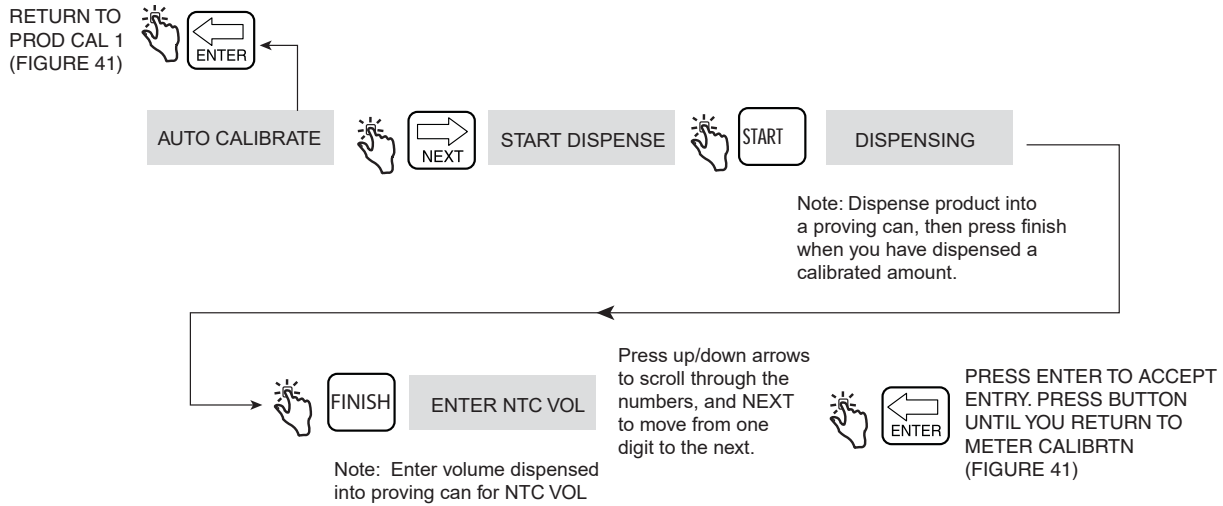

Figure 42. Meter Auto Calibration Setup

MultiCalibrate

Figure 43 illustrates meter MultiCalibration setup procedure.

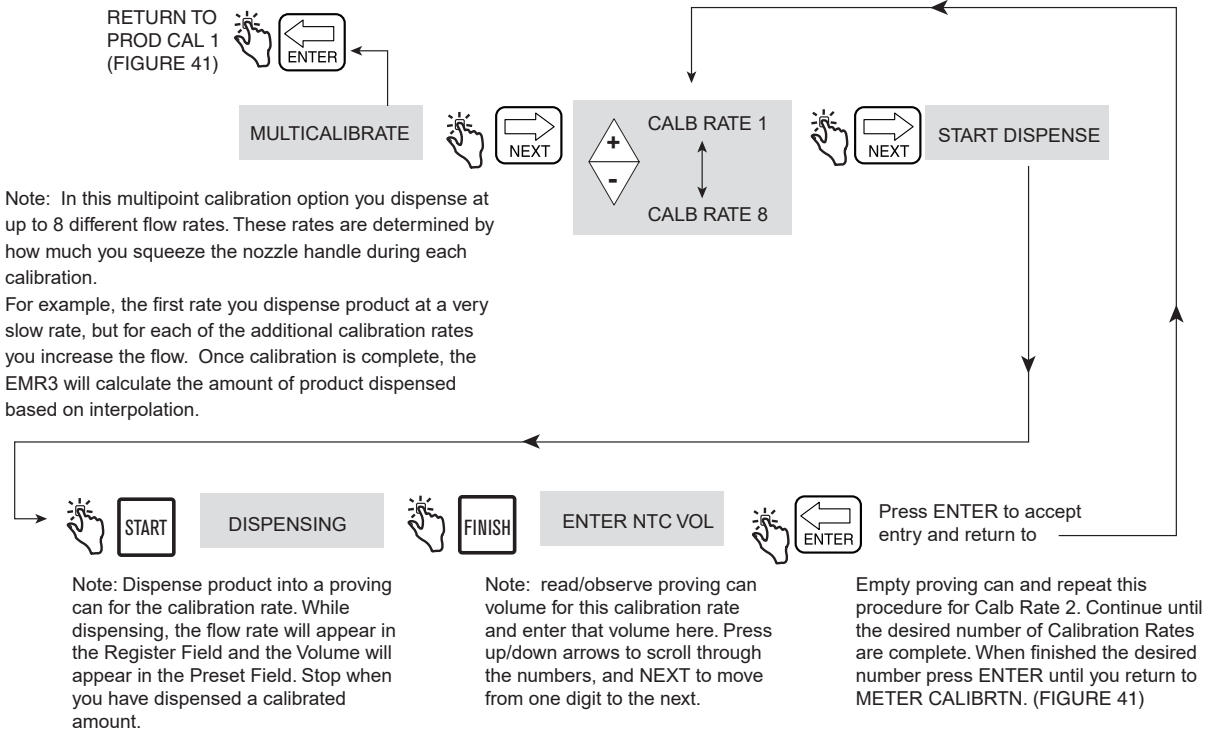
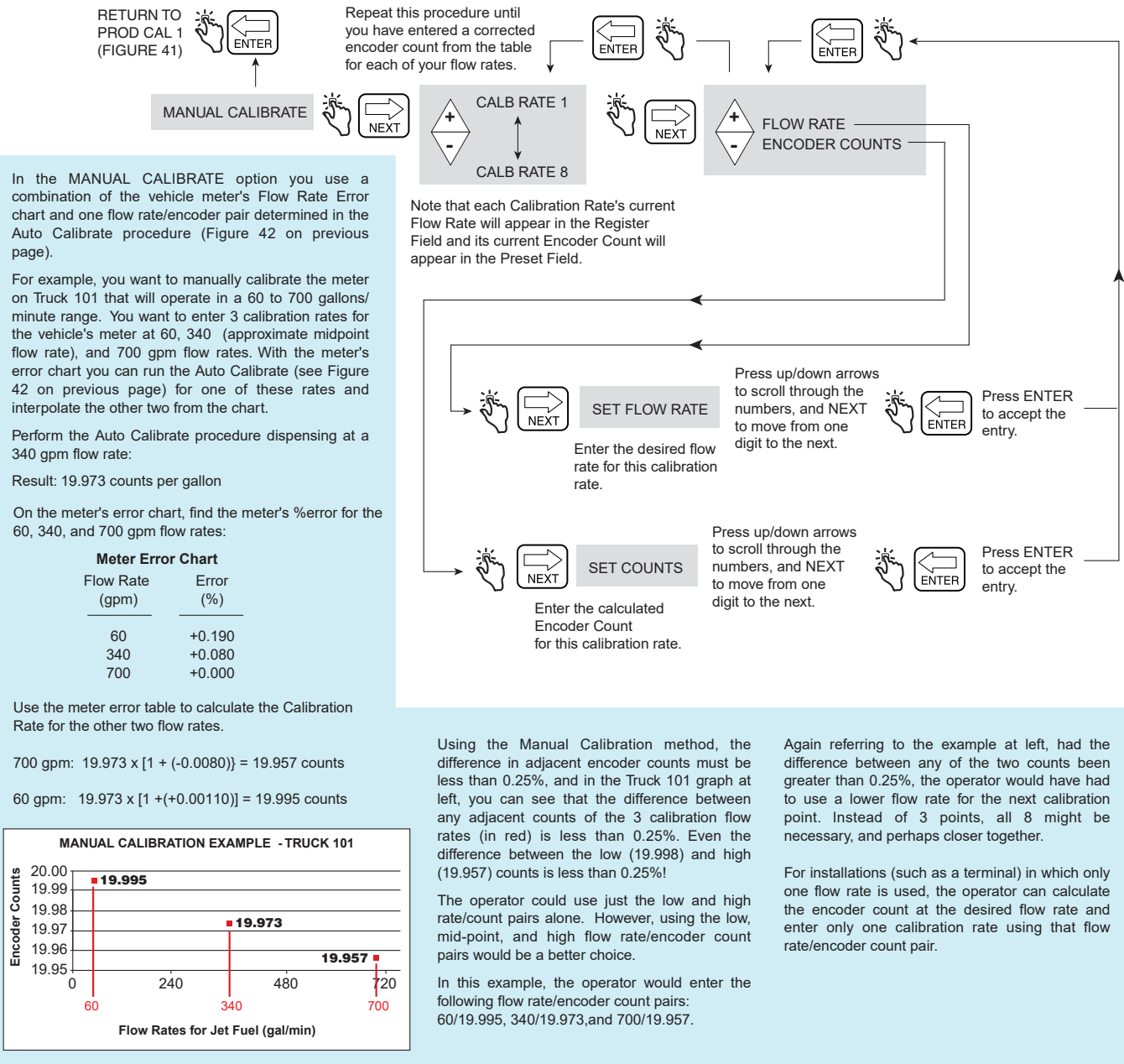

Figure 43. Meter MultiCalibration Setup

Manual Calibration

Figure 44 illustrates meter Manual Calibration (multipoint) setup procedure. This method requires the meter manufacturer's meter error chart.



In the MANUAL CALIBRATE option you use a combination of the vehicle meter's Flow Rate Error chart and one flow rate/encoder pair determined in the Auto Calibrate procedure (Figure 42 on previous page).

For example, you want to manually calibrate the meter on Truck 101 that will operate in a 60 to 700 gallons/minute range. You want to enter 3 calibration rates for the vehicle's meter at 60, 340 (approximate midpoint flow rate), and 700 gpm flow rates. With the meter's error chart you can run the Auto Calibrate (see Figure 42 on previous page) for one of these rates and interpolate the other two from the chart.

Perform the Auto Calibrate procedure dispensing at a 340 gpm flow rate:
Result: 19.973 counts per gallon

On the meter's error chart, find the meter's %error for the 60, 340, and 700 gpm flow rates:

Meter Error Chart	
Flow Rate (gpm)	Error (%)
60	+0.190
340	+0.080
700	+0.000

Use the meter error table to calculate the Calibration Rate for the other two flow rates.

700 gpm: $19.973 \times [1 + (-0.0080)] = 19.957$ counts
60 gpm: $19.973 \times [1 + (+0.0110)] = 19.995$ counts

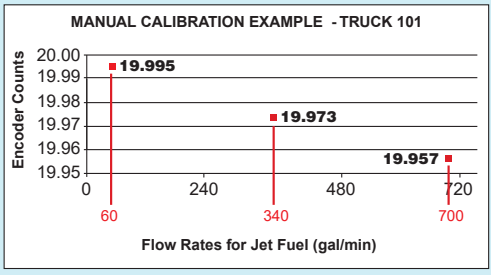

Using the Manual Calibration method, the difference in adjacent encoder counts must be less than 0.25%, and in the Truck 101 graph at left, you can see that the difference between any adjacent counts of the 3 calibration flow rates (in red) is less than 0.25%. Even the difference between the low (19.998) and high (19.957) counts is less than 0.25%!

The operator could use just the low and high rate/count pairs alone. However, using the low, mid-point, and high flow rate/encoder count pairs would be a better choice.

In this example, the operator would enter the following flow rate/encoder count pairs: 60/19.995, 340/19.973, and 700/19.957.

Again referring to the example at left, had the difference between any of the two counts been greater than 0.25%, the operator would have had to use a lower flow rate for the next calibration point. Instead of 3 points, all 8 might be necessary, and perhaps closer together.

For installations (such as a terminal) in which only one flow rate is used, the operator can calculate the encoder count at the desired flow rate and enter only one calibration rate using that flow rate/encoder count pair.

Figure 44. Meter Manual Calibration Setup

CONFIGURE I/O

Figure 45 illustrates Configure I/O setup in C&C Mode.

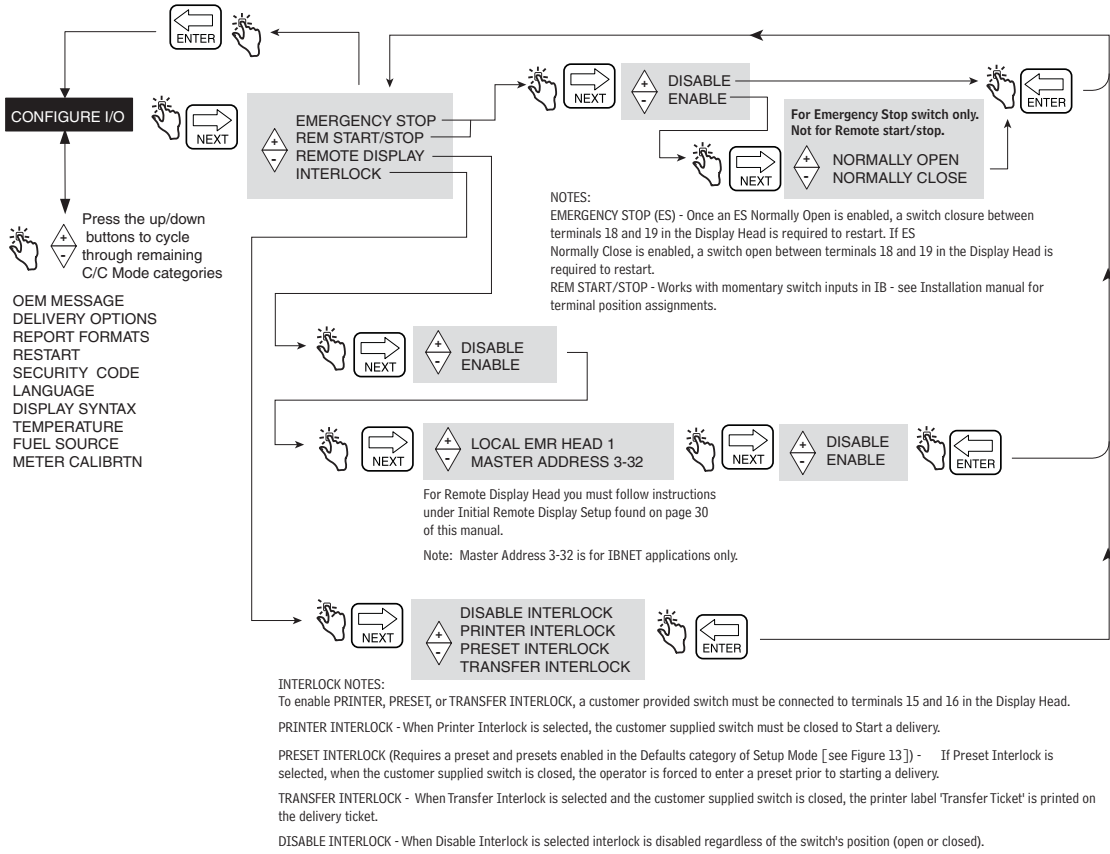

Figure 45. Configure I/O Setup

OEM MESSAGE

Figure 46 illustrates OEM Message setup in C&C Mode.

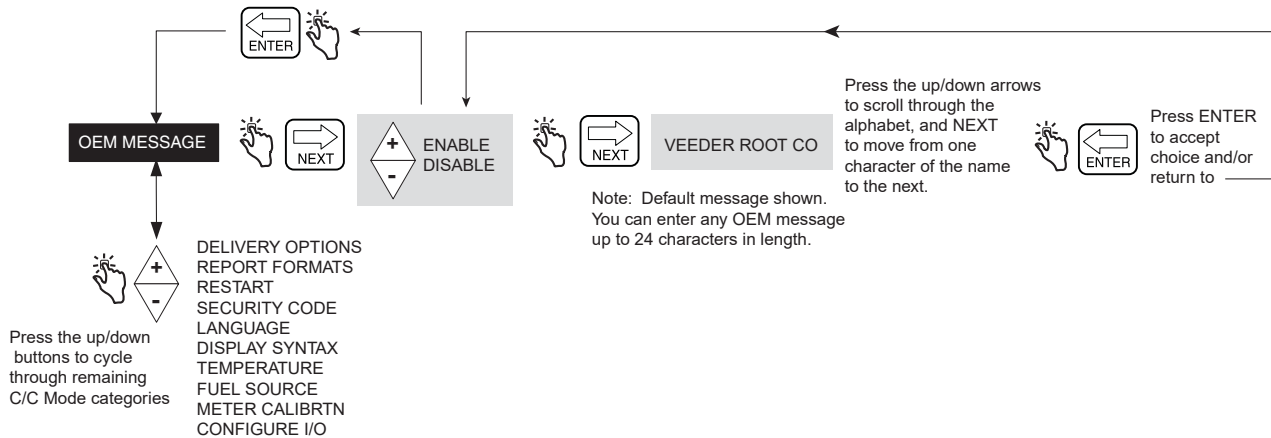

Figure 46. OEM Message Setup

DELIVERY OPTIONS

Figure 47 illustrates Delivery Options setup in C&C Mode. This option lets you enable or disable price changing within the Delivery State as per your regulatory requirements. In this setup you also select coefficient (of expansion) or density as the temperature compensation method for deliveries, enable delivery timeout, enable Tank ID, enable Custom fields, enable Tank Load and enable E04 encoder error (Gross volume and Temperature on Ticket fields also visible when temperature probe connected to EMR Head). Also you can enable / disable Gross Preset, Gross Viewable, Multicalibrate 0.25% Diff and Multiple Delivery.

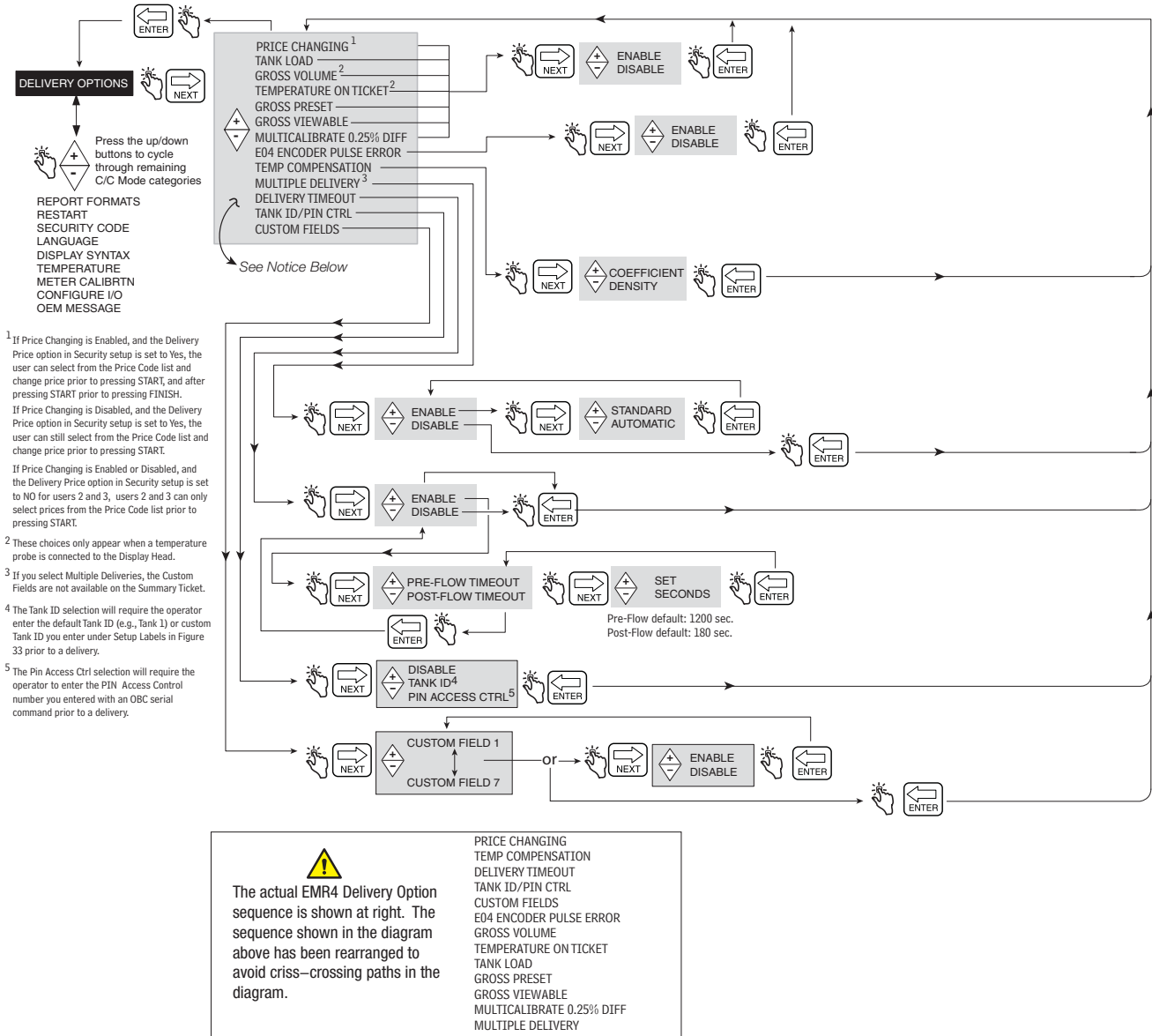

Figure 47. Delivery Options

Idle State Safety Features

Two Idle State safety features (Stop Flow Timeouts) are built into the EMR4 system.

- Pressing the START button puts the EMR4 into the Delivery State. If fuel flow is not detected within 1200 seconds (default), the delivery is terminated. The nozzle icon (Figure 1 on page 4) will begin blinking 30 seconds before delivery is terminated.
- A second idle state occurs when flow is halted during a delivery. The user has 180 seconds (default) to push the FINISH button to complete the delivery or the delivery is terminated.

These timeouts can be enabled or disabled by the Delivery Timeout feature (see Figure 47).

REPORT FORMATS

Figure 48 illustrates the Delivery Ticket and Shift Report Formats that are setup in C&C Mode. In this setup selections can be made that determine which lines (printer labels) will print on Delivery Tickets and on Shift Reports. Two formats each can be selected for Delivery Tickets and for Shift Reports.

To edit label content see Figure 32 on page 33.

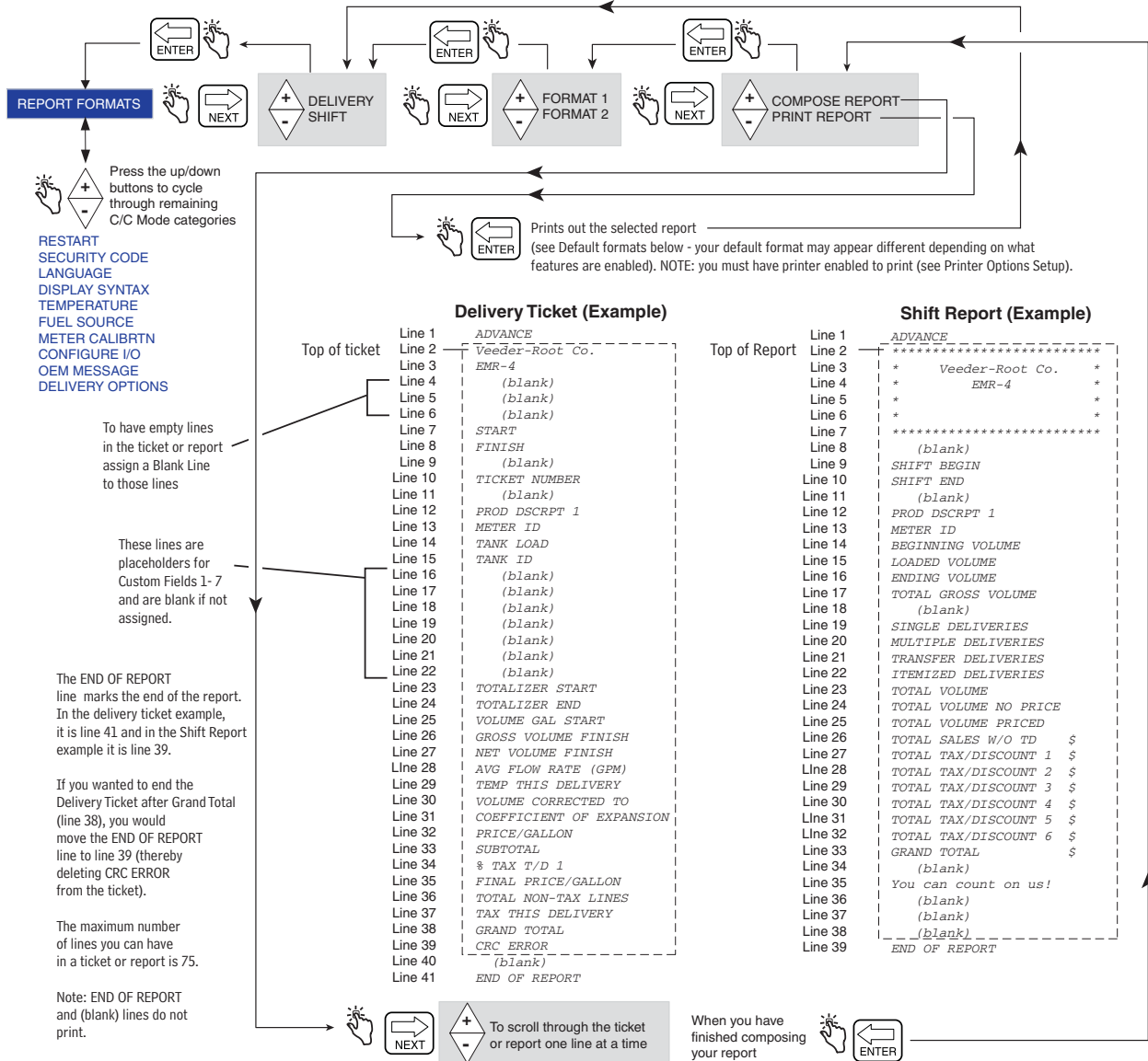

Example: To move (write over) one line on the Ticket/Report with another line.

To move TICKET NUMBER (Line 10) to line 23, press +/- keys until you display TOTALIZER START in the Descriptor Field (its current line number [23] will display in the Preset Field as shown in the example at right). Press NEXT, then +/- keys until you see TICKET NUMBER in the Descriptor Field, then press ENTER to accept the move. NOTE: when you copy one line to another line you write over the destination line's label. Now, you would have TICKET NUMBER on lines 10 and 23 and no TOTALIZER START. You could move a blank line to line 10 or make some other label change on line 10. See Figure on next page for tips on reformatting your reports.

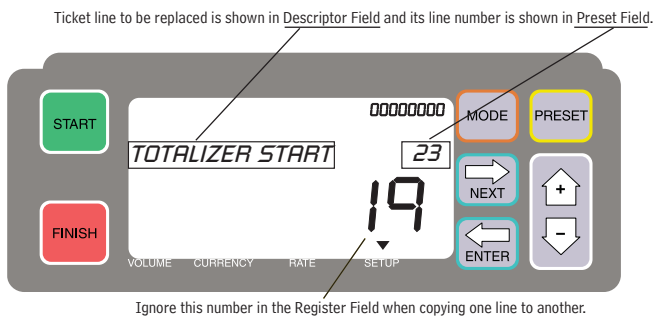

Figure 48. Delivery and Shift Report Formats

Delivery Ticket (Example)

```

Line 1  END OF REPORT
Line 2  | Veeder-Root Co.
Line 3  | EMR-3
Line 4  | (blank)
Line 5  | (blank)
Line 6  | (blank)
Line 7  | START
Line 8  | FINISH
Line 9  | (blank)
Line 10 | TICKET NUMBER
Line 11 | (blank)
Line 12 | PROD DSCRPT 1
Line 13 | METER ID
Line 14 | TANK ID
Line 15 | CUSTOM FIELD 1
Line 16 | CUSTOM FIELD 2
Line 17 | CUSTOM FIELD 3
Line 18 | CUSTOM FIELD 4
Line 19 | CUSTOM FIELD 5
Line 20 | CUSTOM FIELD 6
Line 21 | CUSTOM FIELD 7
Line 22 | TOTALIZER START
Line 23 | TOTALIZER END
Line 24 | VOLUME GAL START
Line 25 | GROSS VOLUME FINISH
Line 26 | NET VOLUME FINISH
Line 27 | AVG FLOW RATE (GPM)
Line 28 | TEMP THIS DELIVERY
Line 29 | VOLUME CORRECTED TO
Line 30 | COEFFICIENT OF EXPANSION
Line 31 | PRICE/GALLON
Line 32 | SUBTOTAL
Line 33 | % TAX T/D 1
Line 34 | FINAL PRICE/GALLON
Line 35 | TOTAL NON-TAX LINES
Line 36 | TAX THIS DELIVERY
Line 37 | GRAND TOTAL
Line 38 | CRC ERROR
Line 39 | (blank)
Line 40 | You can count on us!
Line 41 | (blank)
Line 42 | (blank)
Line 43 | (blank)
Line 44 | END OF REPORT
    
```

Prints only if TC not enabled
Prints only if TC enabled

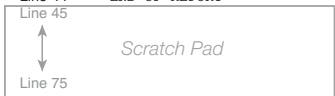

Example 1 - Switching 2 lines

Suppose you want to modify the example Delivery Ticket format as follows:

- Switch TANK ID and METER ID labels

Procedure

Since moving is copy/replace, you have to save the destination line first. Think of the lines following the END OF REPORT line (line 45 in the default example) to line 75 (last possible line) as a scratch pad in which you can 'save' labels before you move them around.

1. Copy METER ID from line 13 to Scratch pad line 45.
2. Copy TANK ID line 14 to line 13.
3. Copy METER ID line 45 to line 14.

The change appears as shown below:

```

→ | Line 12  PROD DSCRPT 1
→ | Line 13  TANK ID
  | Line 14  METER ID
  | Line 15  TICKET NUMBER
    
```

You do not have to go back and write over line 45 in the scratch pad since all lines after the END OF REPORT line (line 44) are ignored.

Example 3 - Inserting a line

IMPORTANT! If you want to insert a line you will have to copy each line below the insert point to the scratch pad, then copy them back into the Ticket/Report format below the inserted line, one by one.

Before beginning an insert, on a clean sheet of paper, list each line number and label you want in the finished report. After you copy all of the necessary lines from the default report into the scratch pad, you can easily use your handwritten report as a guide when copying each line back into the final report.

Figure 49. Delivery and Shift Report Formatting Examples

RESTART

Figure 50 illustrates the Restart procedure in C&C Mode. **CAUTION: DO NOT USE UNDER NORMAL CONDITIONS!**

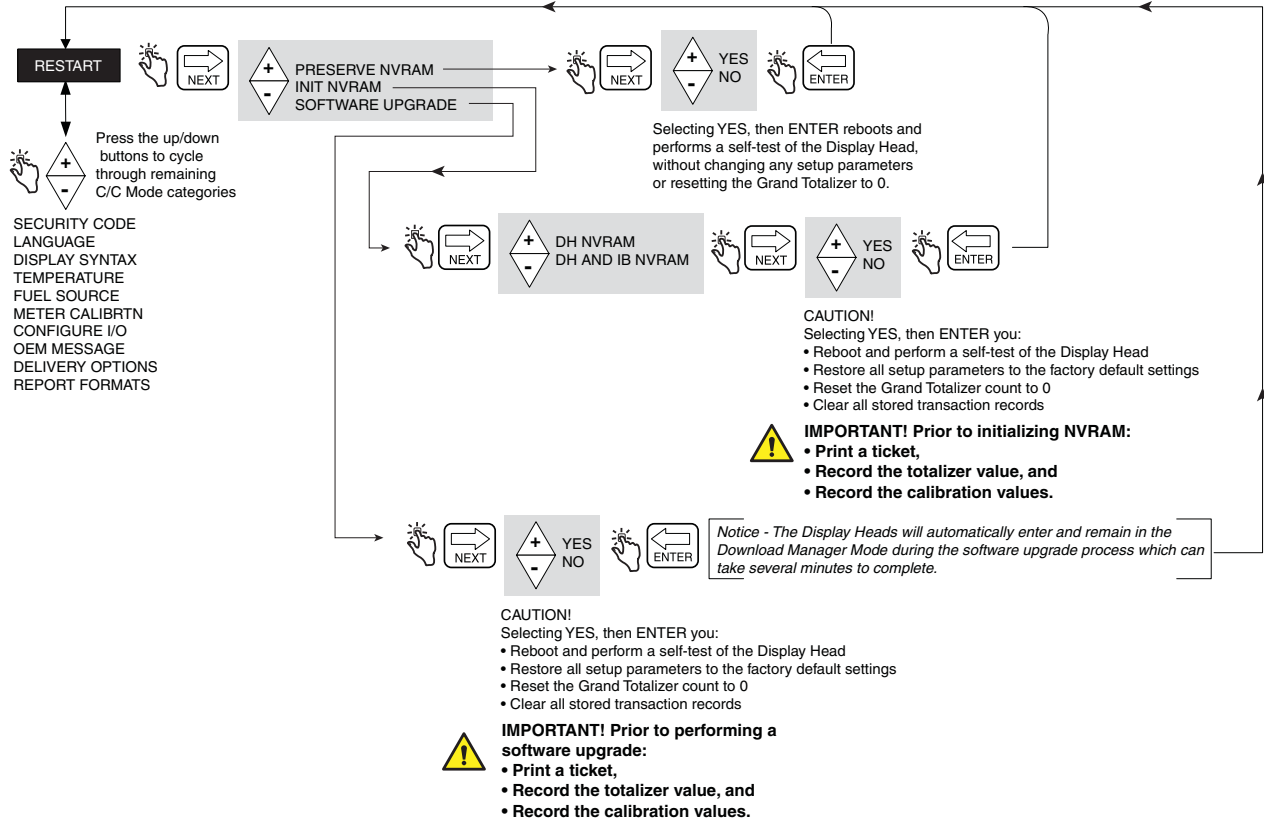

Figure 50. Restart Options

SECURITY CODE

Figure 51 illustrates the Security Code enabling procedure in C&C Mode.

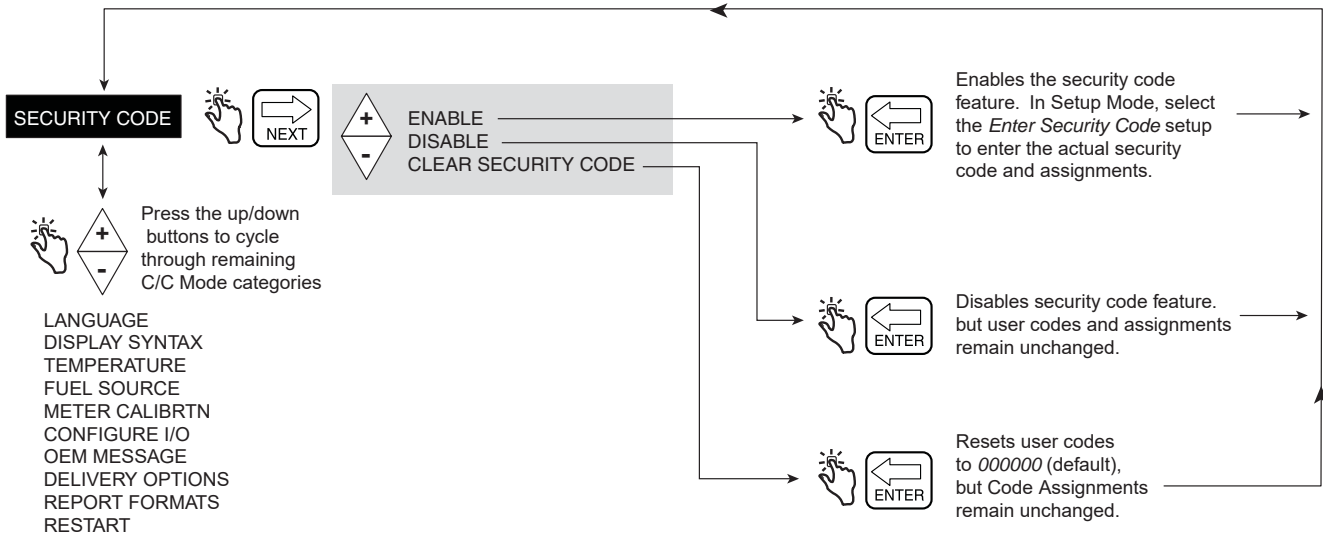

Figure 51. Security Code

When security is enabled and the system is not in C&C mode, users that want to change setup must log in with their security code as shown in Figure 7 on page 13.

Exiting C&C Mode

1. Turn Off power to the Display Head. Disable the C&C Mode by replacing C&C jumper, etc., (see EMR4 Application Guide, V-R P/N 577014-339).
2. Replace cover on Display Head.
3. Turn On power to the Display Head.
4. After the Display Head boots up, press MODE button until you are in Volume Mode.

Operation of the System

Multiple Products

The EMR4 is capable of delivering multiple products through the same meter. If more than one product is set up in the setup menu, when the START button is depressed, the multiple product selection is initiated and the first product is displayed. Press the ∇ button to sequence through the products and press the ENTER button to select the product.

Single Deliveries

The operator presses the START button. The display will show All Segments and then All Zeros displays. The operator may then deliver product to the tank.

Multiple Deliveries

In Delivery Options when Multiple Delivery is enabled EMR4 is capable of delivery to multiple tanks through the same meter. The operator presses the START button until the Multiple Delivery Icon appears in the display and releases it. The operator may then deliver product to the first of multiple tanks. The product selection and preset methods used in the dispensing on a single delivery would apply. Upon completion of the first of the deliveries the START button is pressed to indicate that the delivery to the tank is complete and you are ready to fill the next tank. After all the tanks are full, the FINISH button concludes the transaction and a summary printout is initiated.

Transfer Deliveries

The EMR4 is capable of delivery between compartments without printing a delivery ticket. This delivery type requires that a transfer switch is wired to the Display Head and that Transfer Deliveries is enabled in Configure I/O setup.

The operator turns On the Transfer Switch and presses START to begin the delivery. After dispensing the desired amount, the operator presses FINISH to complete the delivery and printout a Transfer Delivery ticket. The operator turns Off the Transfer Switch.

Multiple Products in Multiple Deliveries

The EMR4 is capable of delivery to multiple tanks through the same meter during a multiple delivery. When the START button is depressed and held down the Multiple Delivery state is evoked and the Multiple Delivery Icon is activated. If the user has setup more than one product the multiple product selection is initiated and the select product message is displayed. If a priced delivery is desired the first product utilizes that price and the operator may then deliver product to the first of multiple tanks. Upon completion of that delivery the START button is depressed and the product selection is reinitiated but flow is not allowed. If a product other than the one previously selected is selected then the user may enter a price in the same way as in pre-delivery. The user then may dispense that product. During the product selection sequence the user may select products but only one price per product is allowed. Therefore the subsequent delivery of product in a multiple delivery is always delivered at the same price. The multiple delivery transaction is concluded in the same way as a multiple delivery with the itemized printout with each product subtotaled.

Driver Selection of Price/with Tax Codes During Operation

The display head is capable of accepting a Price, Discount with an associated Tax Code by the means described in this section.

In the Currency Mode the system defaults to the price prompt. At the price screen the price is displayed in its net value in the Preset Field. The selection of a new price is accomplished by simply pressing the NEXT button. The

price, whether it is the default price previously entered, is displayed in the change price screen with its base value in the preset field and its net value in the register field. The price code is changed by, accepting the Price (pressing the ENTER button) or scrolling to the appropriate price code and accepting (pressing the ENTER button). Alternatively, prior to accepting the price from the two methods described, from the Change Preset screen the NEXT button may be pressed to "write over" the base value in the Preset Field. The new Value is accepted by pressing the ENTER button. After entering the price code, the operator can continue with the delivery. The price code can be changed after START button is pressed except in multiple delivery state after the first dispense of product.

Entry of Price Codes & Tax/Discount Assignment in Setup Mode

The display head is capable of accepting default price and discount & tax entered by the operator between deliveries through the Setup Mode. The price default codes are accessed through the pricing setup screen by pressing the NEXT button to navigate to the Price Code 1 screen. The user then selects the price code that they wish to enter by scrolling to the code of choice. From that chosen price code, the NEXT button is pressed to advance to the change price screen. The price is altered by pressing the NEXT button to navigate to the screen to enter the base price. The price input is accomplished by pressing the NEXT button, scrolling to the desired price, and pressing the ENTER button to accept. The new price is then assigned a Tax Code by pressing the - button to Assign Tax/Discount screen. From this screen the NEXT button navigates to the Assignment screen and scrolling to the appropriate Tax/Discount code, assigned by using the ENTER button. When the user returns to price and navigates to the Tax/ Discount code assignment, T/D Code 1 is displayed.

Entry of Tax/Discount lines to T/D Subtotal

Subtotal feature allows the user to define and insert additional Subtotal lines in the same manner as the existing tax or discount lines. Adding this feature creates a new type, called subtotal (T/D/S). Type subtotal is a new selection in the CHNG T/D/S VALUE menu with no user defined value but it does have the ASSIGN TO LINE selection. Once the T/D SUBTOTAL selection is made, the user can now select to which T/D LINES it will be assigned. Only those lines assigned to the T/D SUBTOTAL are summed together. Using the T/D SUBTOTAL feature creates an additional line to print on the delivery ticket and is now part of the delivery record. The T/D SUBTOTAL will have a Printer Label associated with it and as such it is subject to being modified.

To assign Lines to Subtotal, go to TAX DISCOUNT menu, press NEXT to get T/D/S CODEn, press NEXT to get T/D/S LINEn, press NEXT to get CHNG T/D/S VALUE, press NEXT to get TAXPERCENT, then using +/- buttons go to T/D SUBTOTAL, then press NEXT to get CHNG T/D/S ASSGN, then press NEXT to get ASSGN TO LINE, then assign lines for subtotal using +/-, NEXT and ENTER buttons.

Emergency Stop

The EMR4 has an optional Emergency Stop Switch (ESS) that may be mounted remote to the system. When the Operator activates the ESS, the Emergency Stop Icon displays, the relay contacts are opened, and the system is shut down. To resume delivery, the operator must pull out the switch.

Preset Operation and Tank Topping

The Preset operates in a specific manner in the EMR4. Whether the display is set in Volume or Currency Mode, the Preset is actually counting volume in the background. This is to say changing the value of the preset in Currency Mode, in currency, changes the equivalent volume preset level in the background. The result is the operator may change the preset in either mode in the denomination of that mode with the same result. They can also switch between modes without altering the preset level.

The preset display shows the countdown from the preset level. While doing so, the fuel volume is compared to the Preset value. When the amount dispensed reaches the designated Preset volume or currency slow point, flow

control relay 1 opens and the register displays a slower dispense rate. When the amount dispensed then reaches the designated stop point, flow control relay 2 opens and shuts off flow at the delivery's preset value.

The user can disable the preset during the operation of the unit by pressing the PRESET button to go to the Preset Countdown, selecting disable, and pressing the ENTER Button. Conversely the user may enable the Preset by pressing the PRESET button then pressing ENTER.

The display indicates the Preset is enabled by turning solid the Icon directly to the left of the Preset Field. Alternatively, when the preset is disabled, the same Icon Flashes.

This methodology allows the topping of tanks by setting the preset and dispensing product until the system turns off the flow. At that point if the operator wishes to dispense more product they could disable the preset or set a new Preset, then dispense the desired additional product. When the preset is disabled, the preset display counts past 0 to a negative amount equivalent to the difference between the preset level and the register reading.

Viewing Tank Load During a Delivery

View Tank Load must be enabled in Start Modes setup for this feature to be active. Preset delivery is not possible when View Tank Load is enabled. Note: Tank load is dependent on the volume entered, not the actual tank volume.

The operator presses the START button to begin the delivery and then presses the PRESET button at which time the Descriptor Field will display **View Tank Load** and the Preset Field will display the volume in the tank (Tank Load) at the beginning of the delivery. When the delivery is complete, the operator presses the FINISH button. If desired, the operator can again press the PRESET button to view the post-delivery volume in the tank.

Modifying the Tank Load - For Tank on a Fuel Delivery Vehicle

View Tank Load must be enabled in Start Modes setup and Tank Load must be enabled in Delivery Options setup for this feature to be active. Preset delivery is not possible when View Tank Load is enabled.

After refilling the tank, this feature allows you to enter the full volume of the tank. The operator presses the PRESET button at which time the Descriptor Field will display **View Tank Load** and the Preset Field will display the pre-fillup Tank Load volume. The operator presses the NEXT button to display **Add Tank Load** in the Descriptor Field. The operator presses the NEXT button again and the cursor blinks in the first digit of the Preset Field. Using the keypad buttons the operator enters the full volume Tank Load and then presses the ENTER button to accept the entry. NOTE: NOTE: If you do not enter volume in after each re-fill of the tank, when -999,999 is reached you will get a TANKER LOAD ERROR.

Temperature Compensation Delivery Feature

After pressing FINISH following a Temperature Compensated delivery, the operator can toggle the display between Net Delivered Volume and Gross Delivered Volume by pressing the +/- button. This action toggles the delivered volume on the display only.

Changing Modes and Presets During Operation

The operator may change modes at any time before and during dispensing by pressing the MODE Button. This allows the user to change volume presets, currency presets at any time before and during delivery. Rate of flow may be displayed only during a delivery. Presets and prices that are in the process of being entered are not recorded until the ENTER button is pressed therefore the preset or price remains intact in the case that the MODE button was pressed before the entry was completed. The Preset Icon is absent when no preset has been entered, flashes when preset is disabled, and is solid when enabled.

The following is an example of a delivery that demonstrates this changing of modes and presets. It is not typical but represents the ability to change the modes and presets.

1. Operator selects the price of \$2.00 for the delivery and presses ENTER to accept (no Preset Icon displayed).
2. Presses PRESET button to display the Preset countdown value (No Preset Icon displayed).
3. Presses the NEXT button to set the Currency Preset Of \$200.00 and presses ENTER to accept the value (Preset Icon turns solid).
4. Starts delivery by pressing START Button. If more than one product, select product, then press ENTER.
5. Operator begins dispensing. The Preset Field displays the countdown value of the \$200.00 less the currency value dispensed (Preset Icon remains solid).
6. Presses MODE to go to Volume Mode and presses PRESET button to display the Preset countdown (Preset Icon remains solid; value displayed will be equal to 100 less volume dispensed).
7. Pressing the NEXT button to display current volume preset value (Preset Icon remains solid). The Preset volume value equivalent displayed will be 100.
8. The Operator changes the Preset value to 200 gallons by entering 200 and pressing ENTER to accept (Preset Icon remains solid). Display shows the new countdown number of 200 less the amount dispensed.
9. Presses MODE to display currency price (\$2.00).
10. Pressing the PRESET button displays the countdown value in currency. The equivalent preset currency value displayed is \$400.00 less value of amount dispensed (The Preset Icon remains solid).
11. Presses MODE button to display a flow rate of in gallons/min. (optional).
12. Presses MODE button to display Volume then PRESET button to display the preset countdown of 200 less the amount dispensed (Preset Icon remains solid).
13. 200 gallons is dispensed and the system stops flow.
14. The  button is pressed to display Preset Disable and then ENTER to disable (Preset Icon begins flashing and flow is allowed to continue, while recording negative numbers past the preset value).
15. Operator "tops" the tank off at 210 gallons (Preset Icon continues flashing).
16. Presses ENTER (Preset Icon turns solid) and system stops flow. Preset display shows -10 gallons.
17. Presses FINISH to print the ticket (210 gallons @ \$2.00 per gallon, \$420.00 +taxes = \$420.00+ tax).

Typical Dispensing Examples

The following scenarios outline the steps the operator may take to dispense product. The two basic methods of delivery are Volume and Currency. They are introduced into the default mode selected in set up for pre-dispense. The operator selects the options appropriate for that mode and presses start to begin the actual dispensing. If multiple products are set up they choose from the available products. If a multiple delivery is desired they hold the START button for more than 1 second to place them in the Multiple Delivery State. Dispensing of fuel may begin. After the preset is reached or the desired amount of fuel is dispensed the operator presses the FINISH button to end the delivery. If the preset is reached and the user wishes to "top off" the tank then the preset may be disabled or reset to accomplish the dispensing of additional product.

DISPENSING VOLUME WITHOUT PRESET

1. In Volume Mode, press START button to initiate delivery (if Display Head is configured for more than one product, you must then select a product first and press ENTER).
2. Deliver Product to desired amount.
3. Press FINISH button to print Volume Ticket.

DISPENSING VOLUME WITHOUT PRICE BUT WITH PRESET BEFORE DISPENSING

1. In Volume Mode, press START button.
2. Press PRESET to go to the Preset screen. Press NEXT button to go to Change Preset screen, increment up or down to desired default preset, then press Enter to accept. (If the user wishes to change the default preset to a different number; from the Change Preset screen they press NEXT and increment up or down for each digit, pressing NEXT to move from digit to digit. They press Enter to accept the new number. If the user wishes to disable the preset then press the PRESET button, scroll to Disable and press Enter. The Icon to the left of the preset field is solid when the preset is enabled and flashes when disabled.)
3. Press START to begin delivery - (if Display Head is configured for more than one product, you must then select a product first and press ENTER).
4. Deliver Product until Preset level is reached and flow is shut down.
5. Press FINISH button to print Volume Ticket.

DISPENSING VOLUME WITHOUT PRICE BUT WITH PRESET AFTER DISPENSING

1. In Volume Mode, press START button to initiate delivery (if Display Head is configured for more than one product, you must select a product first).
2. Press PRESET button.
3. Press PRESET to go to the Preset screen. Press NEXT button to go to Change Preset screen, increment up or down to desired default preset, then press ENTER to accept. (If the user wishes to change the default preset to a different number; from the Change Preset screen they press NEXT and increment up or down for each digit, pressing NEXT to move from digit to digit. They press ENTER to accept the new number. If the user wishes to disable the preset then press the PRESET button, scroll to Disable and press ENTER. The Icon to the left of the preset field is solid when the preset is enabled and flashes when disabled.)
4. Deliver Product until Preset level is reached and flow is shut down.
5. After dispensing the preset may be disabled to "top off" tanks by pressing the PRESET button, scrolling to Disable and pressing ENTER.
6. Press FINISH button to print Volume Ticket.

DISPENSING CURRENCY WITH PRICE CODE BEFORE DELIVERY BUT WITHOUT PRESET

1. In Currency Mode, press NEXT button to display Change Price screen.
2. Press +/- button to scroll to the desired price code and press ENTER Button. The net price is displayed. (If the user wishes to alter the price while retaining the associated tax code they press NEXT again to Enter Price screen. Using the NEXT, +/- button, followed by pressing ENTER, the new base price is achieved and the new net price is displayed.)
3. Press START to begin delivery (if Display Head is configured for more than one product, you must select a product first). The Product Description + the Price Unit are displayed in the Description Field, the net price in the Preset Field, and the Total Dispense Value so far is displayed in the Register field.
4. Press FINISH button to print Ticket.

DISPENSING CURRENCY WITH PRICE CODE & CURRENCY PRESET BEFORE DELIVERY

1. In Currency Mode, press NEXT button to display Change Price screen.
2. Press +/- button to scroll to the desired price code and press ENTER Button. The net price is displayed. (If the user wishes to alter the price while retaining the associated tax code they press NEXT again to Enter Price screen. Using the NEXT button, +/- buttons, followed by ENTER button, the new base price is achieved and the new net price is displayed.)
3. Press PRESET button to navigate to Preset screen.

4. Press NEXT button to Change Preset, select the default preset desired then press ENTER button to accept the value. (If the user wishes to alter the preset they press NEXT again to Enter Preset screen. Using the NEXT button, +/- buttons, followed by ENTER button, the new preset value is achieved and the new preset is displayed. If the user wishes to disable the preset they press NEXT then scroll to Disable and press ENTER.) The icon to the left of the preset field will flash when the preset is disabled and remain solid when it is active.
5. Press START to begin delivery (if Display Head is configured for more than one product, you must select a product first). The Product Description + the Price Unit are displayed in the Description Field, the net price in the Preset Field, and the Total Dispense Value so far is displayed in the Register field.
6. Press FINISH button to print Ticket.

DISPENSING CURRENCY WITH PRICE CODE BEFORE & CURRENCY PRESET AFTER DISPENSING

1. In Currency Mode, press NEXT button to display Change Price screen.
2. Press +/- button to scroll to the desired price code and press ENTER Button. The net price is displayed. (If the user wishes to alter the price while retaining the associated tax code they press NEXT again to Enter Price screen. Using the NEXT button, +/- button, followed by ENTER button, the new base price is achieved and the new net price is displayed.)
3. Press START to begin delivery (if Display Head is configured for more than one product, you must select a product first). The Product Description + the Price Unit are displayed in the Description Field, the net price in the Preset Field, and the Total Dispense Value so far is displayed in the Register field.
4. Press PRESET button to navigate to Preset screen.
5. Press NEXT button to Change Preset, select the default preset desired then press ENTER button to accept the value. If the user wishes to alter the preset they press NEXT again to Enter Preset screen. Using the NEXT button, +/- buttons, followed by ENTER button, the new preset value is achieved and the new preset is displayed. If the user wishes to disable the preset they press NEXT then scroll to Disable and press ENTER. The icon to the left of the preset field will flash when the preset is disabled and remain solid when it is active.
6. Press FINISH button to print Ticket.

DISPENSING CURRENCY WITH PRICE CODE AND VOLUME PRESET BEFORE DISPENSING

1. In Currency Mode, press NEXT button to display Change Price screen.
2. Press +/- button to scroll to the desired price code and press ENTER Button. The net price is displayed. (If the user wishes to alter the price while retaining the associated tax code they press NEXT again to Enter Price screen. Using the NEXT button, +/- button, followed by ENTER button, the new base price is achieved and the new net price is displayed.)
3. Press MODE button to navigate to Volume Mode.
4. Press PRESET button to navigate to Preset screen.
5. Press NEXT button to Change Preset, select the default preset desired then enter to accept the value. If the user wishes to alter the preset they press NEXT again to Enter Preset screen. Using the NEXT button, +/- button, followed by ENTER button, the new preset value is achieved and the new preset is displayed. If the user wishes to disable the preset they press NEXT then scroll to Disable and press ENTER. The icon to the left of the preset field will flash when the preset is disabled and remain solid when it is active.)
6. Press MODE to return to Currency Mode.

7. Press START to begin delivery (if Display Head is configured for more than one product, you must select a product first). The Product Description + the Price Unit are displayed in the Description Field, the net price in the Preset Field, and the Total Dispense Value so far is displayed in the Register field.
8. Press FINISH button to print Ticket.

DISPENSING CURRENCY WITH PRICE CODE & VOLUME PRESET AFTER DISPENSING

1. In Currency Mode, press NEXT button to display Change Price screen.
2. Press +/- buttons to scroll to the desired price code and press ENTER Button. The net price is displayed.(If the user wishes to alter the price while retaining the associated tax code they press NEXT again to Enter Price screen. Using the NEXT button, +/- button, followed by ENTER button, the new base price is achieved and the new net price is displayed.)
3. Press START to begin delivery (if Display Head is configured for more than one product, you must select a product first). The Product Description + the Price Unit are displayed in the Description Field, the net price in the Preset Field, and the Total Dispense Value so far is displayed in the Register field.
4. Press MODE button to navigate to Volume Mode.
5. Press PRESET button to navigate to Preset screen.
6. Press NEXT button to Change Preset, select the default preset desired then enter to accept the value. (If the user wishes to alter the preset they press NEXT again to Enter Preset screen. Using the NEXT button, +/- button, followed by ENTER button, the new preset value is achieved and the new preset is displayed. If the user wishes to disable the preset they press NEXT then scroll to Disable and press ENTER. The Icon to the left of the preset field will flash when the preset is disabled and remain solid when it is active.)
7. Press MODE to return to Currency.
8. Press FINISH button to print Ticket.

DISPENSING WITH TANK ID ENABLED

1. The operator is ready to dispense and presses START.
2. The display will show TANK ID (the default label) or whatever was entered in SETUP LABELS (see C&C Mode, Figure 31 on page 32) in the Descriptor Field.
3. Press NEXT, and either; ENTER to accept TANK DEFAULT (or whatever was entered in SETUP LABELS - see C&C Mode, Figure 31 on page 32); or use the +/- button to enter a different label (up to 16 characters). Press ENTER when you have entered the desired label. Note, if you were to press ENTER when TANK ID displays, the message TANK ID NOT ENTERED will scroll across the Descriptor Field. To avoid seeing this message, you have to press NEXT after TANK ID displays.
4. Begin your delivery.

For multiple deliveries when you make the first dispense, you can enter a new TANK DEFAULT label prior to the second dispense. This new label will then appear before the third dispense, forth, etc. until the FINISH button is pressed. On the next dispense, either single or multiple, the TANK DEFAULT label reverts to the SETUP LABELS selection (see C&C Mode, Figure 31 on page 32).

DISPENSING WITH CUSTOM FIELDS ENABLED

1. The operator is ready to dispense and presses START.
2. The display will show Custom Fields (the default label) or whatever was entered in SETUP LABELS (see C&C Mode, Figure 31 on page 32) in the Descriptor Field.
3. The display will show Custom Field 1- Custom Field 7 or whatever was enabled in DELIVERY OPTIONS -> CUSTOM FIELDS (see C&C Mode, Figure 47 on page 48).
4. Press NEXT, and either; ENTER to accept Custom Fields Default i.e. CF1-CF7 (or whatever was entered in SETUP LABELS - see C&C Mode, Figure 31 on page 32); or use the +/- button to enter a different label (up to

16 characters). Press ENTER when you have entered the desired label. Note, if you were to press ENTER when CUSTOM FIELDS displays, the message CUSTOM FIELDS NOT ENTERED will scroll across the Descriptor Field. To avoid seeing this message, you have to press NEXT after CUSTOM FIELDS is displayed.

For single or multiple deliveries, the first three Custom Fields will be used for operator entries at the start of a delivery. The operator either enters a value for each enabled field, or by selecting the ENTER key, accepts the default value for the field.

The last four fields will be used for operator entries at the end of a delivery, after the FINISH key is pressed. The operator either enters a value for each enabled field, or by selecting the ENTER key, accepts the default value for the field. The operator will press FINISH after the final custom field is entered and the delivery is closed as normal and the transaction record is saved with enabled custom fields.

The operator is prompted only for custom fields that have been enabled. For example, if only Custom Field 1 and Custom Field 5 are enabled, there will be one prompt for custom field 1 at the start of delivery and one prompt for custom field 5 at the end of a delivery. There will be no prompt for entry of fields that are not enabled.

If no custom fields are enabled, or none of the last four custom fields are enabled, one press of the FINISH key will close a delivery as normal.

DISPENSING WITH BATCH PRESET BY PRODUCT ENABLED

1. In Volume Mode, press START button to initiate delivery (if Display Head is configured for more than one product, you must select a product first).
2. When a product is selected, (Batch Preset, Transfer Interlock is enabled along with Transfer switch), default batch preset for that product is available in the Preset Field).
3. Press PRESET to go to the Preset screen. Press NEXT button to go to Change Preset screen, then press ENTER to accept. (If the user wishes to change the default preset to a different number; from the Change Preset screen they press NEXT and increment up or down for each digit, pressing NEXT to move from digit to digit. They press ENTER to accept the new number. If the user wishes to disable the preset then press the PRESET button, scroll to Disable and press ENTER. The Icon to the left of the preset field is solid when the preset is enabled and flashes when disabled.)
4. Deliver Product until Preset level is reached and flow is shut down.
5. Press FINISH button to print Volume Ticket.

DISPENSING WITH GROSS PRESET ENABLED

1. In Volume Mode, press START button to initiate delivery (if Display Head is configured for more than one product, you must select a product first).
2. When a product is selected and Temperature compensation is enabled for that product, (Gross Preset is enabled in Delivery options), then Preset value shown is the Gross volume, delivered volume in the Register Field is Net volume.
3. Deliver Product until Gross Preset level is reached and flow is shut down.
4. Press FINISH button to print Volume Ticket.

DISPENSING WITH GROSS VIEW ENABLED

1. In Volume Mode, press START button to initiate delivery (if Display Head is configured for more than one product, you must select a product first).
2. When a product is selected and Temperature compensation is enabled for that product, (Gross View is enabled in Delivery options), then dispensed volume in Register Field is the Gross volume.
3. Deliver Product until required Gross Volume level is reached.
4. Press FINISH button to print Volume Ticket.

DISPENSING WITH MULTIPLE DELIVERIES DISABLED

1. In Setup Mode - Delivery options menu Disable Multiple Delivery.
2. In Volume Mode, press START button to initiate delivery (though START button is pressed for longer time EMR4 will not go in to Multiple Delivery mode).
3. Deliver Product until required Volume level is reached.
4. Press FINISH button to print Volume Ticket.

DISPENSING WITH MULTICALIBRATE 0.25% DIFF DISABLED

The EMR default setting for entering multiple calibration values requires the user to enter values that are within 0.25% of each other. For example the following set of calibration values are acceptable, 99.66, 99.82, 100.08 but the following will cause an E65 – CALIBRATION ERROR: 100.25, 100.93, 101.57. To turn off the E65 error code, just DISABLE the Multicalibrate 0.25% Difference feature.

Take the following steps to disable the Multicalibrate 0.25% Difference feature:

1. In Setup Mode - Delivery Options menu select Multicalibrate 0.25% Diff.
2. Press NEXT button, press +/- button and select DISABLE, then press ENTER button.

REDUCING SLIP PRINTER FONT SIZE

1. In Setup Mode Printer Options, Slip Printer set font size to "FONT 7X7".
2. Take a Test Print to view the reduced font size.

CALIBRATION PAGE PRINT

1. In Setup Mode Printer Options, - PRINT CALIB PAGE, Press NEXT button.
2. Move +/- button to get YES menu, then Press ENTER button to take a print of Calibration values.

SELECT PRODUCT

During a delivery, when more than one product is available, the user must choose one product prior to each delivery. On the front of the display head, press +/- keys to display the desired product, then press ENTER to select it.

EMR4 Troubleshooting Guide

Most errors are the result of poor terminations of wiring, either in a junction box, or at the terminal strips in the IB box or Display Head.

Note: The EMR4 encoder is a 2-channel quadrature pulse output device in which the A-channel leads the B-channel by 90 degrees in order to create 4 unique states.

Available Documentation

For EMR4 hardware related details, see the EMR4 Application Guide, number 577014-339. For information related to menus or settings, see the EMR4 Setup and Operation Manual, number 577014-350. Descriptions of the EMR4 System are available on the UL/cUL Control Drawing, document number 331940-021 or the ATEX System Drawing, document number 331940-022. Veeder-Root documents are available on our web site at: <http://www.veeder.com/us/products/meter-registers/electronic-meter-registers/electronic-meter-register-EMR4>.

Testing an EMR4System

DISPLAY HEAD

To perform a Display Head Complete Self-Diagnostic Check, cycle power to the EMR4 system. To cycle power, turn the power off for at least 20 seconds before turning it on again. During power up, each Display Head automatically tests all its own circuit board hardware in about 30 seconds. If a failure occurs, an error code number described in this guide, is posted on the display.

LCD DISPLAY

To test the LCD Display, simulate a delivery by performing a START and FINISH sequence in Volume or Currency mode. The fueling nozzle icon will appear after pressing the START button. For a brief period of time, all of the segments will turn on, then off. If the unit fails to perform this test, press the FINISH button once, then press START and FINISH again. The nozzle icon should appear after START and disappear after FINISH, if not then the head will need to be replaced.

PULSE GENERATOR INPUT CHECK

With the cover open and the unit NOT in C&C mode, disconnect the spring between the pulse generator and the input shaft. Push start and turn the pulse generator shaft until a nonzero reading appears on the register portion of the display. Press the FINISH button, the nozzle icon turns off and a delivery ticket is printed. BE SURE TO RECONNECT THE SPRING BEFORE REPLACING THE LID.

PRINTER CHECK

Verify ticket printing by either printing duplicate tickets or by simulating a delivery as noted above. Push the FINISH button to display a previous delivery on the register display. To print a duplicate ticket, hold the FINISH button down for a few seconds then release it.

EMR4 Informational Messages

All messages appear in the Display Head's 14-character Descriptor Field (ref. Figure 1 on page 4). System messages can be either informational or describe an error detected by the self-checking functions of the EMR4.

Information messages do not inhibit the operation of the EMR4.

NEW CALIBRATION REQUIRED

After assigning a Product Type or a Cal Number to any Product Description number, this message alerts the user to recalibrate the meter in the Meter Calibration Setup. If the user does not recalibrate the meter, the EMR4 will use an incorrect meter calibration factor to calculate volume.

NO RECORDS

Inside the Display Head there are zero transactions stored. This message appears in the Setup Mode, when the user attempts to print or view transaction records on a new start-up, or after clearing NVRAM by using the RESTART feature in C&C mode. This message does not apply to the transaction records stored in the IB and IB records can be restored back to the Display Head.

RECALCULATING

While in the C&C Mode this message is displayed during the meter calibration procedure when new calibration points are calculated. Each point takes a few seconds to calculate.

NO PRICE ENTRY

While trying to START a delivery, in the Currency Mode prior to selecting a price, the EMR4 will display this message. Once the desired price is on the preset display, use the ENTER button to select it.

SELECT PRODUCT

When more than one product is available, the user must choose one product prior to each delivery. Press +/- button to display the desired product then press ENTER to select it.

Delivery Error Codes

Notice: The current delivery will automatically FINISH when a delivery error occurs.

E04 - ENCODER PULSE ERROR

This error is an indication that an illegal quadrature state has occurred. It is possible this error is caused by a random event and another delivery may be started. Should this error repeat itself, the source of the error must be fixed. Before replacing the encoder check the IB input voltage for dropout or power surges. Some solenoid valves do not have diode suppression and may cause the supply voltage to drop out. Add diodes (Veeder-Root P/N 846000-022) across the solenoid coils as noted in the installation manual. An over speed condition (>2500 rpm) will also cause an E04 error.

E06 - TEMP PROBE TOO HOT

The measured temperature is greater than +160°F (71.1°C) or the thermoprobe wires are shorted together. This error can also be caused by poor connections in a junction box when wire is added to the original temperature probe and a poor connection is made. Soldering is recommended - not just wire nuts.

E07 - TEMP PROBE TOO COLD

When the fluid temperature is outside of the EMR4's measurable range, a delivery can not continue or start. Go into the C&C Menu, under TEMPERATURE, check what the EMR4 reads for the fluid's temperature. If the EMR4 temperature is wrong remove or replace the thermoprobe and recalibrate.

E08 - TEMPERATURE PROBE FAILURE

1. The thermoprobe wires are not connected to the TP terminals on the Display Head. Check the thermoprobe connections on the back of the Display Head. If the thermoprobe wiring is corroded, remove both leads and trim them. Cut back the cable insulation and strip each wire by 1/4 of an inch (5 mm). Insert both wires into the terminal block and tighten. To test a thermoprobe, connect each lead to an ohmmeter and measure the resistance. At 77°F (25°C), the meter should read about 10 K ohms. If not, replace the probe (Veeder-Root P/N 846000-002).
2. The measured temperature is less than -55°F (-48.3°C).

System Error Codes

E20 - RELAY FAILURE OR E50 - IB COMM FAILURE

Serial communication from the IB Box is not working.

- Check the wiring at both the Display Head and the IB, make sure wire A goes to terminal A and B goes to B etc. Also, one end of the cable shield, or drain wire, must be tied to chassis ground using the appropriate saddle clamp hardware.
- In some EMR4 Systems, adding a suppression diode across each dc powered flow control solenoid valve will be required to avoid IB COM FAILURES. See the appropriate DC Solenoid Wiring figures located in the EMR4 Application Guide, Veeder-Root P/N 577014-339.
- Flow-Control Solenoid valves are one source of electrical noise. See the External Sources of System Noise located in Appendix C of this manual for further explanation.

(EMR4 Systems with Dual Heads)

- If the E20 RELAY FAILURE or E50 IB COMM FAILURE continues, try swapping the Display Head 1 wiring with the Display Head 2 wiring. If the problem follows the Display Head, replace it, if not, test the IB board with a known good Display Head. A faulty IB circuit board can also be the cause an E20/E50 IB COMM FAILURE.
- When two display heads are operating from a single IB, an E50 IB COM FAILURE will occur if both heads have the same Head Address. Put the Display Head in Set-up Mode and go to the System Address menu to check the address number for each display head. Cycle the power to EMR4 system to clear the error message once an address change is made.
- In a two display head configuration, if Display Head 1 has a failure, Display Head 2 may also display an E50 IB COM FAILURE. See the Dual Head Set-up information located in Appendix A of this manual.

IB INDICATOR LIGHTS AND IB SELF CHECKS

The tri-color LED, located inside the Interconnect Box, is capable of indicating 4 different states: Green, Red, Yellow and Off (see Figure 54). At start up, the LED flashes the initialization sequence of Off-Green-Red-Yellow-Off indicating that the IB self-test passed with no errors to display. If one or more Display Heads are communicating with the IB the LED will flash an Off-Green-Off pattern repeatedly. If one or more IB Relay is active, or a delivery is in process, the LED will flash an Off-Yellow-Off sequence until all the relays are inactive.

If a communication error occurs, the LED will flash Off-Red-Off indicating a problem. Try swapping the Display Heads as described above in order to locate the problem. The LED will not indicate a non-functional Display Head.

If a self-test error occurs, the LED will flash an Off-Red-Off-Red-Off sequence indicating a problem. Try swapping the IB with another IB in order to locate the problem.

If the LED is stuck in one of the 4 states, remove input power from the input terminals for a few seconds. Restore power and check the LED for the Off-Green-Red-Yellow-Off sequence. If the LED fails to flash in the proper sequence, replace the IB Circuit Board.

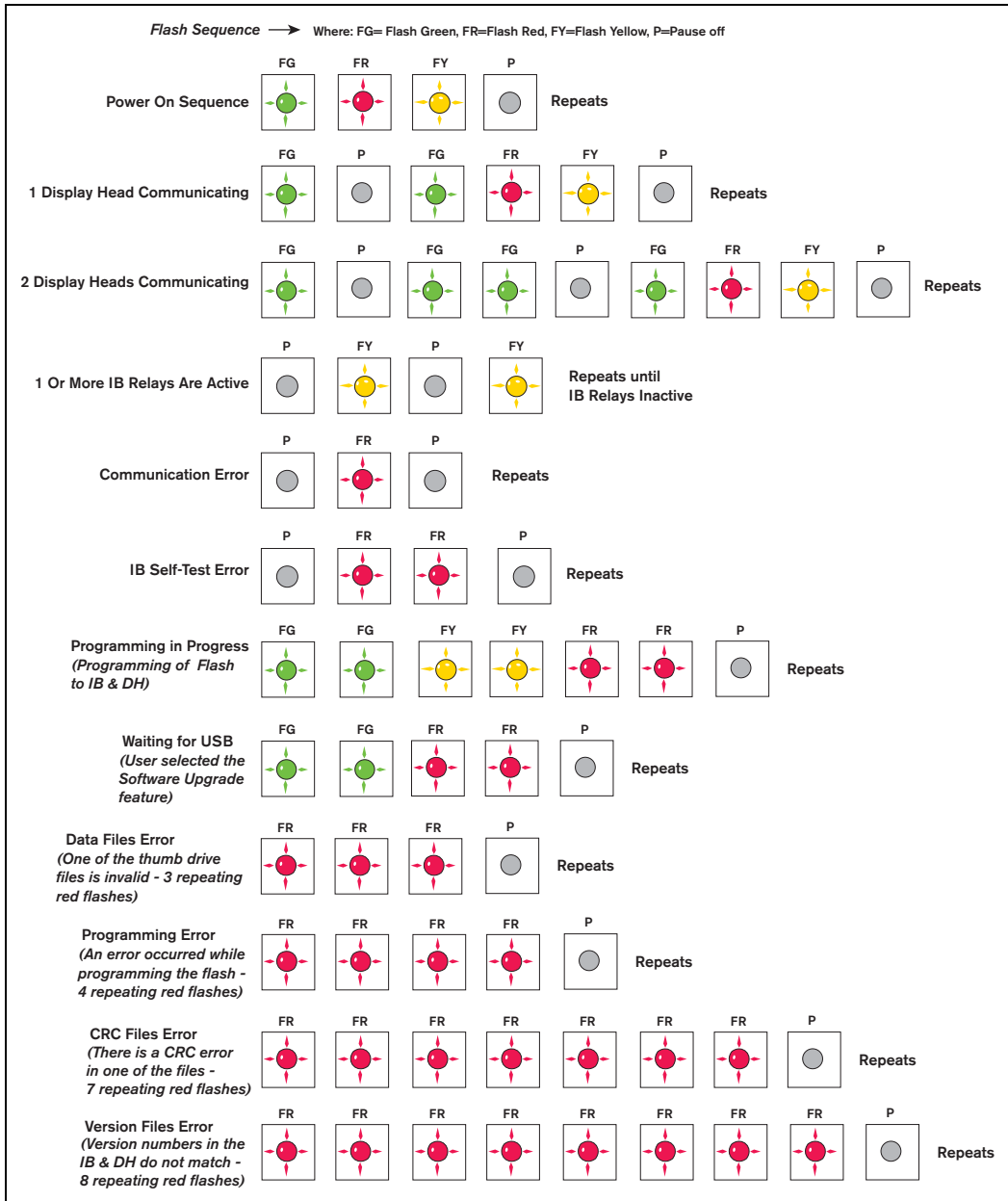

Figure 54. IB Tri-Color LED Status Flash Patterns

E66 - PRINTER BUSY

The E66 Printer Busy error means that the printer still has information to print from the previous transaction. If a transaction is complete, but no ticket was put in the printer, the display can be 'reset' to zero by pushing the FINISH button. When the START button is pushed, the Printer Busy Error comes up. The printer icon should be flashing to indicate there is information to be printed. The ability to 'reset' the register is based on a ticket sensing switch inside the printer that clears once a ticket has been removed. The data that needs to be printed is still however, in the printer's buffer memory as indicated by the flashing icon.

Another possibility is that the previous transaction printed some or most of the information on the ticket, but the ticket was not long enough to print all the information (the printer icon should be flashing). Install a blank ticket into

the printer and the remaining information will finish printing. Keep in mind that if the operator thinks all of the lines printed, there may still be blank lines in the format that have to print to complete the ticket.

Cycling the printer power will clear the printer memory and the Printer Busy Error. However, the transaction record is in the EMR4 system memory and can be recalled using view records or printing records.

Hardware and Printer Busy

If one of the communications wires between the printer and the IB is not connected, the printer will not print, but the printer icon will flash after a transaction. When the ticket is removed, the register can be reset by pushing FINISH, but again, when the START button is pushed, the Printer Busy Error will show because there is still information from the previous transaction to print. To clear this error; (1) connect the printer and let it print, or (2) disable the printer in the setup menu.

EXC ERROR ####

These are 4-digit coded exception processing errors associated with booting up the EMR4 system. Try cycling power Off and On before replacing the Display Head.

ERROR

Error – Indicates a CPU processing error associated with embedded software used by the EMR4 system. Try cycling power to the IB Box before initializing NVRAM and reprogramming the Display Head. Note that this Error may appear in either the Register Field or the Grand Totalizer Field.

Relay Setup Error Codes

Relay setup errors occur while entering relay or preset information in Setup Mode. When using 2-stage valves, relay 1 is used to control the fast-flow solenoid and relay 2 is used to control the single flow solenoid. Under the RELAY CONTROL settings, two values are used to knockoff each solenoid prior to the end of a preset delivery: SET SLOW FLOW (relay 1) and SET ADVANCE STOP (relay 2).

E60 - STOP ADVANCE ERROR

The volume for flow control relay 2 is set to a volume greater than the volume entered for flow control relay 1. Fix this condition by setting the volume for SET ADVANCE STOP to a number of units smaller than the volume for SET SLOW FLOW.

Calibration Error Codes

Calibration errors occur during meter calibration and must be corrected in order to continue with this process.

E64 - FUEL TYPE UNDEFINED

A meter calibration must be performed for this product.

E65 - CALIBRATION ERROR

One of the multipoint calibration values is different by more than 0.25% of the previous value. For example if calibration point 1 is 100.00 than calibration point 2 must be between 99.75 and 100.25 counts. Push any button to clear the error code. Push the NEXT button to begin calibrating a new flow rate point using either Auto Calibrate or Multicalibrate. It is also acceptable to calculate the counts and enter them manually using the manual calibrate feature.

The EMR default setting for entering multiple calibration values requires the user to enter values that are within 0.25% of each other. For example the following set of calibration values are acceptable, 99.66, 99.82, 100.08 but the following will cause an E65 – CALIBRATION ERROR: 100.25, 100.93, 101.57. To turn off the E65 error code, just DISABLE the Multicalibrate 0.25% Difference feature.

Other Problems

SYSTEM BOOTS UP OKAY, BUT DISPLAY KEYS DON'T RESPOND

Electrical interference or noise could cause this problem. Make sure the IB and the Display Head each have a good 'Earth Ground' and the ground/shield between the IB and Display Head is connected. Try to find the source by turning on and off motors/pumps and other equipment in the area. Make sure this equipment is well grounded.

Appendix A: EMR4 Setup - Programming Tips

For Typical Single or Dual-head Installations with One IB

Order	Activity	Comment
1	Time Delays (Setup, non C&C - ref. Figure 29 on page 29)	Increase TIME DELAYS to get screen and backlight to stay on longer. For example, set it to 630 seconds.
2	Printer Option (Setup, non C&C - ref. Figure 17 on page 21)	Enable printer so it is available for use (default is standard slip printer type).
3	Language and labels - defaults to English, must select French (C&C - ref. Figure 31 on page 32)	<ul style="list-style-type: none"> • Defaults to English, Gallons, Dollars. • If French is selected, then all labels change to French. • Note that for French the currency defaults are Euros, and the Euros symbol will be on the ticket format.
4	Display Syntax (C&C - ref. Figure 34 on page 35)	Defaults to tenths for volume. It is recommended that even if you want to display whole unit volume, that you do all calibrations with the display set to tenths of a unit volume, then change to display whole unit volume.
5	Temperature (If Temperature Compensation is desired) <ul style="list-style-type: none"> • Temperature Compensation by Density or Coefficient? (C&C - ref. Figure 40 on page 39) • Temperature - default is Fahrenheit, need to change for Celcius (C&C - ref. Figure 35 on page 36) • Change Reference Temperature from default of 15°C or 60°F? (C&C - ref. Figure 36 on page 36) • Temperature calibration 	Temperature probe must be connected for temperature to be available. <ul style="list-style-type: none"> • Necessary to select for Product Setup (defaults to Coefficient). • Selection of temperature probe units of measurement • Temperature probe's calibration reference temperature units of measurement must match Temperature probe units of measurements • Use ice water bath as per manual, or a known temperature.
6	Meter ID (C&C Fuel Source setup, ref. Figure 37 on page 37)	Text for Meter ID, e.g., the truck number.
7	Input Type and Meter Direction (C&C Fuel Source setup, ref. Figure 37 on page 37)	Defaults to Quadrature input type which is the pulse generator supplied by V-R. In this setup you also change the meter's direction if it is counting backwards. Default is clockwise (CW).
8	Product Setup (Dscrip) (C&C - ref. Figure 40 on page 39)	<ul style="list-style-type: none"> • 8 products available. • Select Product Type first. this loads the proper Temperature Compensation table/factor and assigns the default name to the product. If necessary, you can change the Product Name in this same setup.

Order	Activity	Comment
9	Meter Calibration (C&C - ref. Figure 41 on page 44)	Normally you would select Autocalibrate. Note: Non-compensated prover volume. Once calibrated, do proofs for yourself and W&M under normal volume delivery mode. Toggle between compensated and non-compensated volume with arrow (+/-) keys on the EMR4 display. Compensated volume has thermometer.
10	Configure I/O (C&C - ref. Figure 45 on page 47) <ul style="list-style-type: none"> • Emergency Stop • Remote Start/Stop • Printer Interlock • Preset Interlock • Transfer Interlock • Remote Display and What Master 	Typical applications do not require these features. Turn on these features only as needed.
11	OEM Message (C&C - ref. Figure 46 on page 47)	This text message displays when the system is idle.
12	Delivery Options (C&C - ref. Figure 47 on page 48)	<ul style="list-style-type: none"> • Price changing defaults to enable. Disable means that the delivery price cannot be changed once a delivery has started. • Delivery Timeout disable defeats the 3-minute time out. This feature should not be disabled for normal truck deliveries, except for aviation deliveries.
13	Report Formats - Delivery Ticket (C&C - ref. Figure 48 on page 50)	Line-by-line ticket format setup.
14	Printer Option - Set Advance (Non-C&C ref. Figure 17 on page 21)	This is where you change the space between the top of the ticket and the first printed line.
15	Security <ul style="list-style-type: none"> • Security Code (C&C - ref. Figure 51 on page 53). • Security (Non-C&C ref. Figure 16 on page 20) 	<ul style="list-style-type: none"> • Enable, Disable, Reset Code. If Enable, security setup is then available. The default is Disable. • This setup is blocked if the Security Code (above) is disabled.
16	Start Screens Defaults (Non-C&C Defaults/Start Modes, ref. Figure 12 on page 16)	These are the Default Screens (Mode) Default is Volume mode.
17	Presets (Non-C&C Defaults/Presets, ref. Figure 13 on page 17)	Up to 3 volume (and 3 currency) presets are available for selection. Volume defaults are 100, 200, and 500, but you can change these.
18	Relay Control (Non-C&C, ref. Figure 15 on page 19)	This is where the relays "volume to go" for 2-stage presets are adjusted. Defaults are 5 and 0.1. You may want to change 5 to 3.

Order	Activity	Comment
19	Tank ID <ul style="list-style-type: none"> • Enable under C&C Delivery Options/Tank ID (ref. Figure 47 on page 48) • Enter Tank ID under C&C Language/Label Changes/Setup Labels/Tank ID (ref. Figure 31 on page 32) • Change Tank ID default under C&C Language/Label Changes/Setup Labels/Tank ID Default (ref. Figure 31 on page 32) 	If enabled, you are required to enter an ID for each delivery.
20	View Records (Non-C&C, ref. Figure 19 on page 23)	You can view and print up to the last 50 transactions.
21	Shift Report ((Non-C&C, ref. Figure 21 on page 25)	This is where the Shift Report capability can be accessed. Between the "Accept" Start and "Accept" End times you get a summary of the transactions. You can also enter Load and Odometer information. Load information is adjusted by the transactions.
22	Shift Report Format (C&C Report Formats ref. Figure 48 on page 50)	If you want a special Shift Report then set it up in the same way as the Delivery Report/Ticket.
23	Date Format (Non-C&C, ref. Figure 23 on page 26)	If you want a date format other than the default.
24	Time/Date (Non-C&C, ref. Figure 24 on page 27)	Set date and time.
25	System Address (Non-C&C, ref. Figure 25 on page 27)	Defaults okay for typical truck with two heads noted above. Terminal installations with more than one IB, consult V-R.
26	Version Number (Non-C&C, ref. Figure 30 on page 30)	This is a read-only system. These numbers are the official W&M software numbers.
27	Restore Records (Non-C&C, ref. Figure 20 on page 24)	Only to be used in special cases.
28	Restart (C&C, ref. Figure 50 on page 52)	<u>CAUTION! DO NOT USE FOR NORMAL OPERATION - WILL REBOOT DISPLAY TO FACTORY SET DEFAULTS AND YOUR SETUP INFORMATION WILL BE ERASED.</u>

Appendix B: Epson Printer Characters

Epson Printer Characters			
A	P	'	9
B	Q	&	8
C	R	"	7
D	S	%	6
E	T	€ ¹	5
F	U	\$	4
G	V	£ ²	3
H	W	>	2
I	X	≡	1
J	Y	<	0
K	Z	∧	
L		/	
M	\	-	
N	?	+	
O	,	✳ ³	

¹The Euro symbol looks like
 on the EMR4 display.

²The pound symbol looks like
 on the EMR4 display.

³The star symbol looks like
 on the EMR4 display.

Appendix C: External Sources of System Noise

SYSTEM BOOTS UP, BUT DISPLAY HEAD DOES NOT RESPOND CORRECTLY

Electrical interference or noise could cause this problem. Make sure the IB and the Display Head each have a good Earth Ground and the ground/shield wire between the IB and Display Head is connected. Try to find the noise source by turning on and off motors/pumps and other equipment in the area. Make sure this other equipment is also well grounded.



For technical support, sales or
other assistance, please visit:
www.veeder.com

A blue rectangular box containing a white globe icon at the top and contact information for technical support and sales below it.